

Workforce Issues and the Treatment of Alcohol Problems: A Survey of Managers of Alcohol and Drug Treatment Agencies

A Report Prepared for the
Australian Government Department of Health and Ageing

by

**Katrina Wolinski
Margaret O'Neill
Ann Roche
Toby Freeman
Aylza Donald**

National Centre for Education and Training on Addiction



© Commonwealth of Australia 2003

ISBN 0 642 82316 2

This work is copyright. Apart from any use as permitted under the *Copyright Act 1968*, no part may be reproduced by any process without prior written permission from the Commonwealth available from the Department of Communications, Information Technology and the Arts. Requests and inquiries concerning reproduction and rights should be addressed to the Commonwealth Copyright Administration, Intellectual Property Branch, Department of Communications, Information Technology and the Arts, GPO Box 2154, Canberra ACT 2601 or posted at <http://www.dcita.gov.au/cca> .

Opinions expressed in this publication are those of the authors and do not necessarily represent those of the government.

Publication approval number: 3319 (JN 7900)

Acknowledgements

The managers of alcohol and other drug specialist services who participated in this study are thanked for the generous contribution of their time, support and interest in this project.

Publications Production Unit
Australian Government Department of Health and Ageing

Contents

Tables	vii
Figures	ix
Abbreviations	x
EXECUTIVE SUMMARY	xiii
Prevalence of alcohol problems	xiii
Agencies with an alcohol focus	xiii
Other drug problems	xiv
Treatment services	xiv
Treatment approach	xiv
Funding levels	xiv
Staff vacancies	xv
The alcohol and other drug workforce	xv
Workforce development	xvi
INTRODUCTION	1
Background	1
Rationale	2
Design	2
Literature review	2
Survey	3
LITERATURE REVIEW	5
Introduction	5
Part 1: Key issues surrounding alcohol consumption	6
Patterns of alcohol use	6
Comorbidity	7
Polydrug use	7
Alcohol-related harms	8
Priority groups	9
Summary	11
Part 2: Current responses to alcohol-related problems	11
Inpatient and outpatient treatment	11
Pharmacotherapy	12
Brief interventions	13
Detection and screening	13
Barriers to GP intervention and screening	14
Summary	15
Part 3: Who should respond to alcohol-related problems?	16
The alcohol workforce	16

Specialist and generalist workers	17
Rural professionals	19
Other professionals	20
Summary	21
Part 4: What are the workforce development issues in responding to alcohol related problems?	21
Workforce development	21
Workforce development strategies	22
Summary	25
Conclusion	25
METHODOLOGY	27
Sampling frame	27
Ethics approval	27
Survey instrument	27
Section 1: The agency	27
Section 2: The workforce	28
Section 3: Workforce development issues	28
Section 4: Demographics	28
Pilot study	28
Study implementation	28
Data collection	29
Limitations	29
Non-response rate	30
Data analysis	31
RESULTS	33
Subjects' participation details	33
Managers' demographic details	34
Managers' gender and age	34
Time spent in the AOD field and current managerial position	35
Managerial and AOD education, training and/or experience	36
Alcohol and other drugs	37
Alcohol focused agencies	38
Prevalence of alcohol-related problems	40
Trends in alcohol-related presentations	42
Trends in polydrug-related presentations	43
Ability to manage and respond to trends effectively	44
Characteristics of AOD agencies	45
Types of organisations	46
Services offered by AOD agencies	47
Client groups served	47
Treatment approach	49

Funding levels	49
Staff vacancies	50
Identifying the AOD workforce	52
Staff development and training	53
Workforce development	56
Defining workforce development	56
Workforce development issues	57
DISCUSSION	59
Treatment philosophy and orientation	59
Alcohol	59
Alcohol and polydrug use	61
Service provision	62
Client access	63
Youth	63
Families	64
Comorbidity	64
Rural needs	64
Funding	67
Workforce issues	66
Agency managers	66
Staff of AOD agencies	66
Staff development	67
Staff vacancies	67
Recruitment	68
Retention	68
Workforce development	69
Summary	70
Conclusion	71
REFERENCES	73
Appendix a: survey instrument	79
Appendix b: state breakdowns	91

Tables

Table 1:	Total number of staff working in 318 specialist treatment agencies and an estimate of staff within the 486 agencies listed on the 2001 COTSA database	xv
Table 2:	Conditions resulting or partially resulting from alcohol consumption (Ridolfo & Stevenson, 2001).	8
Table 3:	Alcohol-related harms and appropriate treatment or prevention strategies and corresponding workforce responses.	18
Table 4:	Classification of frontline professions (from Roche, 1998).	19
Table 5:	Non-respondents details (n=231)	30
Table 6:	Number of completed surveys and participating agencies by state/territory	33
Table 7:	AOD specialist treatment agency managers' professional backgrounds	36
Table 8:	OD qualifications of specialist managers (n=233)	37
Table 9:	AOD specialist agencies' treatment focus by state/territory (n=234)	38
Table 10:	Managers' perception of the most problematic drug reported by clients (n=227)	41
Table 11:	Distribution of AOD treatment organisations by metropolitan and non-metropolitan location (n=234)	46
Table 12:	Types of services provided by AOD specialist treatment agencies in Australia	46
Table 13:	Treatment services provided in 2002 by AOD specialist treatment agencies (n=234)	47
Table 14:	Managers' identification of the principal client group catered by their agency (n=234)	48
Table 15:	Type of treatment approach used in the AOD government, non-government, and private sectors	49
Table 16:	Managers' perception of adequacy of funding by type of organisation	50
Table 17:	Managers' perceptions of the difficulty filling vacancies by type of organisation (n=231)	51
Table 18:	Top eight qualities perceived by managers as important when employing AOD staff	52
Table 19:	Summary table of staff working in 318 specialist treatment agencies and an estimate of staff numbers for the 486 valid agencies listed on the 2001 COTSA database	53

Table 20:	Reported (and estimated) number of therapeutic staff working in 318 (and 486) AOD specialist treatment agencies	54
Table 21:	Managers' description of their agency's staff development and training initiatives (n=233)	55
Table 22:	Frequency of uptake of staff development and training initiatives (n=223)	55
Table 23:	Managers' response to the question 'do the staff development programs supported by your agency adequately prepare people to respond to AOD problems?' (n=220)	55
Table 24:	A typology of managers' understanding of workforce development	56
Table 25:	Managers' identification of workforce development issues within specialist treatment agencies, by type of organisation and rank ordered by frequency of response	57
Table 26:	Type of treatment agency by state/territory	91
Table 27:	Type of service provided by agency by state/territory	91
Table 28:	Adequacy of funding by state/territory and organisation (n=232)	91
Table 29:	Difficulty filling vacancies by state/territory and organisation	92

Figures

Figure 1:	Prevalence of alcohol consumption in the Australian population	6
Figure 2:	Percentage of the population who drink at medium to high risk levels for acute harm at least once a month	7
Figure 3:	Shaw et al.'s (1978) Model of Therapeutic Commitment.	15
Figure 4:	De Geyndt's Framework of workforce development for the health workforce	22
Figure 5:	Proportion of males and females in a sample of 234 AOD specialist treatment agency managers	34
Figure 6:	AOD specialist treatment agency managers by age and gender	35
Figure 7:	Length of time managers have spent in the AOD field	35
Figure 8:	Length of time spent in current managerial position	36
Figure 9:	The treatment focus of AOD specialist agencies	38
Figure 10:	The proportion of government, non-government and private organisations among AOD specialist treatment agencies and the proportion that provide alcohol focused services	39
Figure 11:	Managers' estimates of the percent of clients who report alcohol as their primary problematic drug	40
Figure 12:	Managers' estimates of the percent of polydrug using clients who report alcohol as part of their problem	41
Figure 13:	Managers' perception of the five most problematic drugs of clients presenting to AOD specialist services (ranked from 1 st to 5 th position) [Note: different denominators used in each drug group]	41
Figure 14:	Managers' perception of past and future trends for alcohol presentations (n = 232 & 234 respectively)	42
Figure 15:	Managers' perception of past and future trends for polydrug use presentations (n = 232 & 233 respectively)	43
Figure 16:	Managers' ability to respond effectively to future alcohol and polydrug trends	44
Figure 17:	Proportion of managers from government, non-government and private agencies (n=234 managers)	45
Figure 18:	Managers' perception of the adequacy of their funding (n=232)	50
Figure 19:	Managers' perception of difficulty in filling staff vacancies (n=231)	51
Figure 20:	AOD workforce reported for 318 AOD specialist agencies (65% of agencies on the COTSA database) and estimated workforce for 486 valid agencies listed on the 2001 COTSA database	53
Figure 21:	The top nine occupational groups working in the AOD treatment sector	54
Figure 22:	A schema of alcohol-related presentations	60

Abbreviations

AA	Alcoholics Anonymous
ADCA	Alcohol and other Drugs Council of Australia
AIHW	Australian Institute of Health and Welfare
AOD	Alcohol and Other Drug
APSAD	Australian Professional Society on Alcohol and other Drugs
ATSI	Aboriginal and Torres Strait Islanders
COTSA	Clients of Treatment Service Agencies
FAS	Foetal Alcohol Syndrome
IDRS	Illicit Drug Reporting System
NCETA	National Centre for Education and Training on Addiction
NDARC	National Drug and Alcohol Research Centre
NGO	Non Government Organisation
NIDS	National Illicit Drug Strategy
SPSS	Statistical Package for Social Sciences
TAFE	Technical Adult Further Education

**“...It’s nice to finally see
some work being done
on alcohol.”**

An Australian AOD treatment service manager,
May 2002

Executive Summary

This report presents key findings from a national survey of managers of Alcohol and Other Drug (AOD) specialist treatment agencies. It provides an initial analysis of the alcohol workforce, AOD services, AOD problems and workforce development issues faced by the sector.

The primary focus of the study was to examine the provision of specialist alcohol services, and associated workforce development issues. All specialist agencies were surveyed. Hence, most findings relate to the AOD specialist sector overall. The report provides important information and insights about Australia's specialist agencies, and is one of few studies of its type.

- This study entailed a survey of managers of alcohol and other drug (AOD) specialist treatment agencies across Australia.
- The Clients of Treatment Service Agencies (COTSA) database, comprising 549 treatment agencies, was used as the sampling frame.
- Two hundred and thirty four managers participated in the survey (representing a total of 318 agencies).
- The overall response rate was 65%.
- The project commenced in February 2002 and was completed in December 2002.

Prevalence of alcohol problems

Managers of alcohol and other drug agencies reported high levels of alcohol problems:

- 63% of managers identified alcohol as the number one problematic drug of clients presenting to AOD specialist treatment agencies
- 45% of clients are estimated to have a primary alcohol problem and 53% of polydrug using clients experience alcohol-related problems
- over the next 3-5 years most managers (70%) estimated alcohol-related presentations would increase or remain static. Nearly a quarter reported that they would not be able to respond to these trends effectively due to lack of resources, shortage of staff and inadequate funding.

Agencies with an alcohol focus

- Managers of agencies with an exclusive focus on alcohol comprised 14% (n=32) of the total sample. Of the remaining participants 10% managed agencies with an illicit drug focus and 76% managed agencies with a combined AOD focus.
- Three quarters were located in New South Wales, Queensland, Victoria and Western Australia.
- Most (44%) were government organisations (38% non-government and 19% were private).
- A small number of agencies provided treatment services for specific client groups including Aboriginal and Torres Strait Islanders, adults, clients with co-morbid problems and navy personnel.

- A small number of gender specific services were provided.
- No alcohol specific services were reported for youth (i.e. <18 years of age).
- 47% of alcohol specific agencies offered inpatient rehabilitation services, whereas 25% and 24% of agencies with an illicit drug or combined AOD focus offered inpatient rehabilitation services, respectively.

Other drug problems

- 63% of managers reported an increase in polydrug presentations over the past 12 months and 63% also predicted increases in polydrug-related presentations over the next three to five years.
- Increased use of amphetamine type stimulants was identified as the major contributor to increases in polydrug-related presentations.
- One in four managers indicated that they would not be able to manage these increases effectively.

Treatment services

This study identified that AOD agencies offered an extensive range of treatment services:

- Outpatient services (n=144) were offered more frequently than residential services (n=100).
- Counselling, referral, assessment and education were offered by over three quarters of the sample.
- Dual diagnosis services were reported by 6% (n=14) of AOD agency managers.

Treatment approach

Harm minimisation was the dominant treatment approach reported by 77% (n=181) of managers of AOD agencies (see Section 4). The definition of harm minimisation included abstinence.

Harm minimisation was supported by:

- 90% of government agencies
- 71% of non-government agencies
- 53% of private organisations.

Funding levels

Most (72%) managers indicated their organisations' funding was inadequate:

- 84% of non-government organisations reported inadequate funding.
- Non-metropolitan based organisations reported inadequate funding more frequently than metropolitan areas (78% vs 69%).
- In non-metropolitan areas, 90% of non-government organisations reported their funding to be inadequate.
- 58% of managers of alcohol focused and illicit drug focused agencies indicated their funding was inadequate compared to 76% of managers who ran combined AOD agencies.

Staff vacancies

Filling available staff positions was a major concern:

- 64% of managers from all sectors (government, non-government and private) had difficulty filling staff vacancies.
- greatest difficulty in filling vacancies was reported by government agency managers in non-metropolitan areas (78%).
- 63% of managers from alcohol focused and combined agencies identified difficulty filling staff vacancies, compared to 71% of managers from illicit drug focused agencies.

The alcohol and other drug workforce

This study is the first known project to examine the size and composition of Australia’s specialist AOD workforce. Managers of 318 agencies provided details of staff numbers and professional disciplines (see Table 1).

Reported figures were extrapolated to provide an estimate for the total (adjusted) number of agencies on the 2001 COTSA database.

Managers

Managers of agencies:

- were predominantly female (57%)
- 46 years (range 23-69) of age on average
- nearly half had been in their current managerial position for less than two years
- possessed varying levels of managerial and AOD education, training and experience
- identified management training as a high priority.

Table 1: Total number of staff working in 318 specialist treatment agencies and an estimate of staff within the 486 agencies listed on the 2001 COTSA database

Type of staff	N	(%)	Total estimated staff (COTSA)
Therapeutic staff			
Nurses	1,206	(26)	1,843
AOD workers	873	(19)	1,334
Psychologists	400	(8)	611
Counsellors	272	(6)	416
Social workers	265	(5)	405
Other occupational groups	1,674	(36)	2,558
Total therapeutic staff	4,690	(70)	7,167
Other staff	1,811	(27)	2,768
Alcohol specific staff	167	(3)	255
All staff	6,668	(100)	10,190

Workforce development

Workforce development needs identified for the AOD sector included:

- more and/or better education and training
- increased funding levels
- a need for additional staff to backfill short and long-term absences and/or vacancies
- increased professionalisation of the AOD workforce.

Introduction

In 2002, the National Centre for Education and Training on Addiction (NCETA) conducted a survey of managers from specialist alcohol and drug treatment agencies across Australia. The purpose of the study was to obtain information on the capacity of agencies to identify and manage risky, hazardous and dependent alcohol use.

The study aimed to:

- identify the proportion of alcohol-related problems within specialist treatment agencies
- determine the nature and size of the alcohol workforce and
- describe workforce development issues.

This report presents the background, rationale, methodology and results from the project.

Background

Alcohol is the second most widely used drug in Australia after caffeine (Single and Rohl, 1997), and is perceived as embedded in Australian culture (Commonwealth of Australia, 2001). However, there are numerous severe, acute and chronic harms associated with alcohol consumption (Ridolfo and Stevenson, 2001) which are a major source of morbidity and mortality in Australia.

Collins and Lapsley (2002) estimated the total social cost of alcohol abuse in 1998-9 at \$7.6 billion. The total for illicit drugs was \$6.1 billion. These figures represent tangible social costs such as workforce/household labour, health care, road accidents, fires and crime as well as intangible costs such as loss of life, pain and suffering. The prevalence of misuse and associated harms, and the social cost of alcohol abuse define alcohol as a significant problem in Australia.

Important changes have occurred in recent years in relation to the patterns and correlates of alcohol use. Over the past 10 years, patterns of use have changed such that alcohol-related problems no longer predominate with middle-aged and older men. There has been a marked increase in problematic alcohol use among young people (Stockwell et al., 2001), associated with both acute and chronic harms. Similarly, patterns of alcohol use among women, and notably young women (Roche & Deehan, 2002), are also changing and there is growing concern regarding associated problems such as foetal alcohol syndrome (FAS).

Changes in patterns of alcohol use and characteristics of clients presenting for treatment raise questions about the capacity of Australian AOD specialist treatment agencies to meet the diverse needs of these client groups. Very little is known about the nature of the AOD field, its workforce and the systemic, organisational and individual workforce development challenges that inhibit or facilitate workers engaging with clients with an alcohol or other drug problem.

To date, only three studies have been conducted that examine specialist treatment agencies. The first is the COTSA census, the most recent of which was carried out in 2001 (Chen et al., 1992, Shand and Mattick, 2002, Torres et al., 1995, Webster et al., 1990). The second is the first report based on the National Minimum Data Set from 2000-2001 (AIHW, 2002b). The third is a small study of 43 agencies undertaken by Pitts (2001). The first two studies have a strong focus on client characteristics while the third provides a brief overview of agency workforce issues.

These studies do not provide a level of agency detail commensurate with the present work. They are also unable to supply current data on aspects of service provision and workforce development issues impacting on the capacity of agencies to effectively engage with clients who have an alcohol or other drug problem.

Rationale

The predominance of alcohol in Australian society, the risks associated with its misuse and the changing trends in client presentation justify an exploratory ‘scoping’ study into the prevalence of alcohol-related presentations to AOD specialist treatment agencies. Currently, relatively little is known about the workers who engage with these clients and the capacity of agencies to provide effective intervention.

Design

This project involved two distinct components:

- a comprehensive literature review and
- a survey of managers of specialist alcohol and drug treatment agencies.

Literature review

A comprehensive literature review was undertaken to provide a context for the project. This review examined evidence in relation to:

- key issues associated with alcohol consumption, including patterns of use, associated harms, comorbidity and polydrug use
- current responses to alcohol-related problems, including inpatient and outpatient treatment, pharmacotherapies, detection and screening and brief interventions
- the workers engaging with clients with alcohol-related problems, including the classifications of professionals in the alcohol workforce
- the broad workforce development issues surrounding the treatment and management of alcohol-related problems, including strategies such as education and training, supervision, partnerships and dissemination strategies.

Literature was sourced from diverse areas including medicine and medical education, education, social science, health promotion and psychology. Relevant electronic databases and library catalogues were searched using the key words alcohol, workforce, specialist, generalist, alcohol-related harms, alcohol-related problems, screening and brief intervention. Results were limited to English documents published from 1990 onwards. The databases searched included Psycinfo, Drug, Medline, Eric and Cinahl. In addition, ‘gray’ literature such as reports and conference proceedings were actively sought out. Bibliographies of relevant documents were also searched for additional literature.

Survey

The sampling frame for the project was based on the database of agencies used for the 2001 Clients of Treatment Service Agencies (COTSA) census. A detailed survey was developed that obtained information on:

- the agency
- services provided
- the proportion of alcohol-related presentations
- the AOD workforce overall
- workforce development issues
- managers' demographic information.

Literature Review

Introduction

Alcohol is the second most widely used drug in Australia after caffeine (Single and Rohl, 1997), and is seen as embedded in Australian culture (Commonwealth of Australia, 2001). However, there are numerous severe acute and chronic harms associated with alcohol consumption (Ridolfo and Stevenson, 2001). Acute and chronic alcohol-related harm is a major source of morbidity and mortality in Australia.

Consumption of alcohol is viewed within this literature review in terms of patterns of use, comorbidity with mental illness, polydrug use and special priority groups. There are a variety of treatment, prevention and intervention options available for alcohol-related problems, including brief intervention and pharmacotherapies. As a result, a wide range of professionals find themselves dealing with alcohol-related problems in the course of their work (Ask et al., 1998).

While there is a substantial literature on responding to alcohol-related problems, comparatively little is known about the alcohol workforce. In addition to specialist and generalist health professionals, other professions such as teachers, bar managers, bar staff and police have a role in preventing or responding to alcohol-related problems.

Workforce development is a vital issue for the alcohol workforce and includes education, training and structural and systemic change to improve the capacity of the workforce to engage with clients with alcohol-related problems. Hence, in order to minimise alcohol-related harm, an analysis of patterns of alcohol consumption, associated problems, and issues in professionals' responses to alcohol-related problems is vital.

This literature review will provide this analysis by summarising recent literature on these issues. The review is divided into four parts:

1. Issues surrounding alcohol consumption, including patterns of use, associated harms, comorbidity and polydrug use.
2. The nature of responses to alcohol-related problems, including inpatient and outpatient treatment, pharmacotherapies, brief interventions, detection and screening, and barriers to GP intervention and screening.
3. The professionals engaging clients with alcohol-related problems, including classifications of professionals in the alcohol workforce, and possible workforce responses to alcohol-related harms and
4. The broader workforce development issues surrounding responses to alcohol-related problems, including strategies such as education and training, supervision, partnerships, and dissemination strategies.

Part 1 Key issues surrounding alcohol consumption

The five main issues that emerged from the literature surrounding alcohol consumption are patterns of alcohol use, comorbidity of alcohol and drug problems with mental illness, polydrug use, alcohol-related harms, and the special populations who may be at elevated risk of these harms.

Patterns of alcohol use

The majority of alcohol-related harms come not from individuals dependent on alcohol, but from moderate to low consumers who occasionally consume at hazardous levels (i.e. “binge-drinkers”) (Roche, 1999, Roche, 1997). Hence, it is important to not only focus on dependent users of alcohol, but also on other drinking patterns in order to minimise alcohol-related harm (Roche, 1997).

Results from National Household Surveys indicate that the proportion of the population who are regular drinkers has remained fairly constant for the last decade, at approximately 60% (Miller and Draper, 2001). Figure 1 outlines the proportion of the Australian population who abstain from alcohol or consume at low, medium or high-risk levels for chronic harm according to the 2001 National Household Survey (Australian Institute of Health and Welfare, 2002). Males are more likely than females to drink at levels of high-risk for chronic harm (3.5% for males, 2.2% for females). Males are also more likely to drink at medium or high-risk levels for acute harm (i.e. excessive drinking in a single session).

Figure 1: Prevalence of alcohol consumption in the Australian population

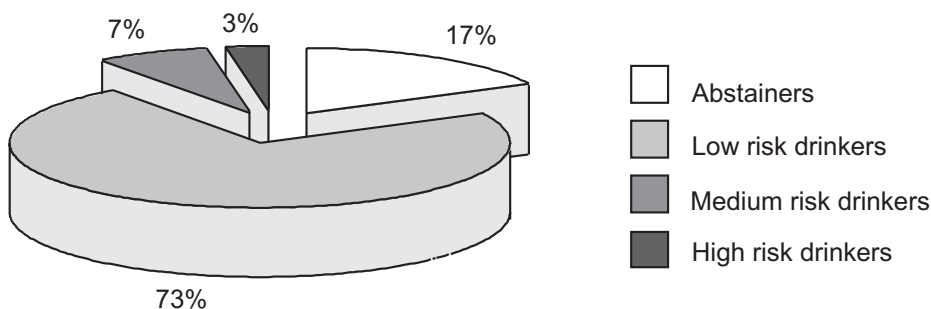

(Australian Institute of Health and Welfare, 2002).

Drinking at medium or high-risk levels for acute harm was most common in the 14-19 and 20-29 age groups, where 20% of males aged 14-19 and 28% of males aged 20-29 drink at medium or high-risk levels for acute harm at least once a month. Twenty one percent of females aged 14-19 and 27% of females aged 20-29 drink at medium or high-risk levels for acute harm at least once a month (Australian Institute of Health and Welfare, 2002). Prevalence of medium to high risk drinking at least once a month by age group is shown in Figure 2. Hazardous drinking also varies by state (Miller and Draper, 2001). The proportion of the population who engage in hazardous drinking is highest in the Northern Territory (11% using a conservative estimate), and lowest in Tasmania (5%), New South Wales (5%) and Victoria (5%) (Miller and Draper, 2001).

In addition to acute problems, a significant proportion of alcohol-related problems involves alcohol dependence (Caetona and Cunradi, 2002). There is some evidence that levels of

Figure 2: Percentage of the population who drink at medium to high risk levels for acute harm at least once a month (Australian Institute of Health and Welfare, 2002).

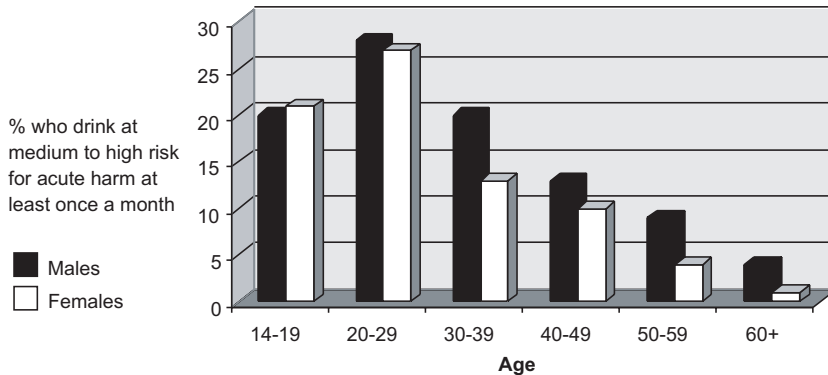

dependent use have been increasing over the last few decades in North America (Holdcraft and Iacono, 2002), although Caetona and Cunradi (2002) report no change in the prevalence of alcohol dependence in the USA from 1990 to 1995. Holdcraft and Iacono (2002) found that rates of alcohol dependence have been increasing among individuals born after 1951. In addition, the rate of increase in alcohol dependence among women was twice that of males, reducing the gap between male and female rates of alcohol dependence (Holdcraft and Iacono, 2002). Individuals are also becoming dependent at a younger age and the duration of dependent drinking is increasing (Holdcraft and Iacono, 2002). It is cautiously assumed that as similar social changes have been experienced in Australia during the last three to four decades that comparable changes may also exist here.

Comorbidity

There is growing evidence of comorbidity of alcohol or drug problems and mental illness. It is estimated that 25% of people with a mental illness also engage in problematic alcohol or other drug use (Saunders and Robinson, 2002). The National Survey of Mental Health and Well-Being found that 20% of individuals with alcohol dependence met the criteria for an anxiety disorder, and 24% met the criteria for an affective disorder (Degenhardt et al., 2000). In addition, alcohol has been found to exacerbate the symptoms of anxiety disorders and social phobias (Stockwell and Bolderston, 1987). Levels of depression and anxiety are higher among individuals who consume alcohol at a hazardous level than individuals who consume alcohol at low risk levels (Caldwell et al., 2002). Given the high risk drinking levels of young adults and the concomitant projected increase in depression, it is probable that members of the alcohol workforce will be increasingly required to treat clients with mental illnesses in addition to problematic alcohol use (Caldwell et al., 2002). In fact, Saunders and Robinson (2002) report that a survey of AOD workers concerning which disorders they came into contact with most frequently indicated that AOD workers reported encountering depression and anxiety disorders more commonly than alcohol or drug dependence disorders. Special workforce development challenges exist in relation to comorbidity.

Polydrug use

Problems associated with alcohol consumption are further complicated by polydrug use. The National Survey of Mental Health and Well-Being found that 51% of individuals who met the criteria for alcohol dependence were also using other drugs (Degenhardt et al., 2000). The most common drugs used in addition to alcohol were tobacco and cannabis. Furthermore,

15% of individuals who met the criteria for alcohol dependence also met the criteria for cannabis dependence and a further 7% met the criteria for dependence on another drug. Alcohol consumption combined with injecting drug use raises the additional concern of hepatitis C. Approximately 64% of injecting drug users who are infected with hepatitis C consume alcohol (Sladden et al., 1998), which has complications for liver disease (Farrell, 2002). Of these current drinkers, 46% had moderated their intake due to a hepatitis C viral infection. Brief intervention has been found to be effective in reducing levels of alcohol consumption among injecting drug users and may help individuals who inject drugs and have hepatitis C to reduce their alcohol intake (Stein et al., 2002). Polydrug use, and dependence on more than one drug may create problems for services specialising in the treatment of alcohol-related problems, as it may not be possible or useful to treat alcohol problems without addressing other co-occurring drug use.

Alcohol-related harms

High-risk alcohol consumption is a pervasive problem in Australia with a wide range of documented harmful effects (Commonwealth of Australia, 2001). Alcohol-related harms are a major and increasing source of morbidity and mortality (Chikritzhs et al., 2000). Alcohol misuse is estimated to be responsible for over 3000 deaths annually, and over 72,000 hospitalisations (Chikritzhs et al., 2000). The health problems related to alcohol consumption also result in a financial impact on the community, estimated at \$7.6 billion per annum including health care costs, legal costs and decreased worker productivity (Collins & Lapsley, 2002).

A list of acute and chronic morbidity and mortality identified by Ridolfo and Stevenson (2001) as resulting or partially resulting from alcohol consumption is shown in Table 2.

Table 2: Conditions resulting or partially resulting from alcohol consumption (Ridolfo and Stevenson, 2001).

Acute	Chronic	Combination
Motorist injuries	Breast cancer	Stroke
Motorcyclist injuries	Heart failure	Suicide
Pedestrian injuries	Unspecified liver cirrhosis	Self-inflicted injury
Fall injuries	Oropharyngeal cancer	
Low birthweight	Oesophageal cancer	
Supraventricular cardiac dysrhythmias	Liver cancer	
Pancreatitis	Laryngeal cancer	
Fire injuries	Hypertension	
Drowning	Ischaemic heart disease	
Aspiration	Cholelithiasis	
Occupational and machine injuries	Psoriasis	
Assault	Epilepsy	
Child abuse	Oesophageal varices	
Alcoholic psychosis	Gastro-oesophageal haemorrhage	
Alcohol abuse	Pancreatitis	
Ethanol toxicity	Alcohol dependence	
Methanol toxicity	Alcoholic liver cirrhosis	
Alcoholic beverage poisoning	Alcoholic poly neuropathy	
	Alcoholic cardiomyopathy	

Harms associated with high levels of alcohol consumption can be categorised as either chronic or acute harms. Chronic harms result from extended periods of regular, excessive drinking and include cancer, heart disease, stroke, liver disease, pancreatitis, gastritis, epilepsy, dementia, depression and suicide (Commonwealth of Australia, 2001). Acute harms result from shorter periods of hazardous drinking, and include road injuries, fire injuries, drowning, and occupational and machine injuries (Chikritzhs et al., 2000).

Priority groups

Minority ethnic groups, Indigenous Australians, females, youth and the elderly are at an elevated risk for alcohol-related harms, and/or have special treatment needs (Commander et al., 1999, Shand and Mattick, 2002, Swift and Copeland, 1998, Stockwell et al., 2001, McInnes and Powell, 1994). These priority groups raise issues of accessibility and the need for specialised AOD treatment services and have specific workforce development implications.

Minority ethnic groups and Indigenous Australians

Research from England has suggested that minority ethnic groups are not receiving the same standard of care as the majority of the population (Commander et al., 1999). In Australia, the COTSA census provides information on individuals from ethnic backgrounds. According to the most recent census conducted in 2001 (Shand and Mattick, 2002), 11% of individuals receiving treatment for alcohol or other drug problems were born overseas (Shand and Mattick, 2002). Over the past decade COTSA has identified a decrease in the percentage of clients receiving treatment who were born overseas. Whether this decrease in clients represents a decrease in the number of individuals born overseas, who are experiencing AOD problems, or whether this population is turning to more culturally appropriate agencies is unknown and warrants further investigation.

Indigenous Australians are particularly at risk for alcohol-related harm. Sixty eight percent of Indigenous drinkers consumed alcohol at hazardous levels, compared to 11% for the general drinking population (National Drug Strategy, 2002). The level of alcohol consumption among Indigenous Australians is also related to socio-economic status; more socio-economically disadvantaged Indigenous Australians tended to have higher levels of alcohol consumption (McLennan and Madden, 1999). Excessive consumption of alcohol has been linked with cultural dispossession and related to social stress and disruption among dispossessed Indigenous cultures across the world (Office of Torres Strait Islander Health, 2001). The COTSA census also provides information on the number of Indigenous individuals receiving treatment for alcohol-related problems. The proportion of Indigenous clients receiving treatment for alcohol problems has decreased since 1990, but Indigenous individuals receiving treatment for problems related to other drugs had increased sharply (Shand and Mattick, 2002).

Women

As well as ethnic minorities, the review has identified concerns that females may not be receiving adequate services (Commander et al., 1999, Swift and Copeland, 1998). Concerns about the ability of females' to access satisfactory treatment stem from findings on the additional needs of female clients (Ask et al., 1998, Copeland et al., 1993, Pangbourne, 1995). Female clients have been found to face barriers such as child care difficulties, sexual harassment from male clients (reported as a problem by 56% of organisations, Swift and Copeland, 1998), issues arising from pregnancy, and the desire for female counsellors, especially for female clients who have histories of sexual abuse (Copeland et al., 1993, Pangbourne, 1995). Approximately 86% of females presenting with alcohol dependence report sexual or physical abuse some time in their lives, and 50% report sexual abuse in adulthood (Copeland et al., 1993). However,

Copeland et al. (1993) found that introducing women-only treatment services with residential childcare facilities did not significantly improve treatment outcomes for females with severe alcohol problems over traditional treatment services, although the majority of clients rated the initiatives and approaches of the women-only service as very useful.

In the COTSA surveys, a similar pattern is evident for female clients as for Indigenous clients. The number of females receiving treatment for alcohol-related problems has decreased, while the number of females receiving treatment for other drug problems has increased (Shand and Mattick, 2002). The COTSA surveys show that fewer females than males are receiving treatment for alcohol-related problems (Chen et al., 1992, Shand and Mattick, 2002, Torres et al., 1995). The National Survey of Mental Health and Well-Being shows that males are three times more likely than females to develop alcohol dependence (Proudfoot and Teesson, 2001). However, females develop alcohol dependence at lower rates of consumption and at an earlier age than males (Roche and Deehan, 2002). It remains unclear whether females are under-served by treatment services. Trend data on women's alcohol consumption patterns suggest that this may remain an important area to monitor (Roche and Deehan, 2002).

Youth and the elderly

Youth have been found to be at the greatest risk of alcohol-related harm by age group (Stockwell et al., 2001). According to the 2001 National Drug Strategy Household Survey (Australian Institute of Health and Welfare, 2002), 20% of males aged between 14 and 19 consume alcohol at a high-risk level at least monthly, compared to 15% of all age groups. Similarly, 21% of females aged between 14 and 19 consume alcohol at a high-risk level at least once a month, compared to 12% of all age groups. The 2001 COTSA census (Shand and Mattick, 2002) found that 25% of people receiving treatment for alcohol or drug problems are 24 years old or younger. Of these youth, 48% were being treated for alcohol-related problems. While the number of youth being treated for alcohol or drug problems has increased since 1990, the percentage being treated for alcohol problems has decreased and the percentage being treated for other drug problems such as amphetamines and cannabis has increased.

Elderly individuals, as well as youth, may also require special attention from AOD organisations and health professionals. While alcohol consumption and problematic alcohol use declines with age (Adams and Cox, 1995), there are concerns that alcohol or drug related problems among the elderly are substantially under-diagnosed (McInnes and Powell, 1994). McInnes and Powell (1994) estimated that only 25% of elderly patients admitted to hospital who had alcohol or drug related problems were diagnosed and only 10% received referrals to specialist treatment. Furthermore, elderly patients may have additional needs when undergoing treatment (Brower et al., 1994). Symptoms associated with withdrawal are more common and more severe among elderly patients (Brower et al., 1994). On average, elderly patients had higher blood pressure, greater cognitive impairment, more headaches and daytime sleepiness and experienced more weakness than younger patients while receiving inpatient detoxification treatment for problematic alcohol use. As a result, Brower et al. (1994) suggest that elderly patients have greater needs during withdrawal, and may require specialised treatment.

Summary of priority groups

In summary, research indicates that ethnic minorities and females may have reduced accessibility to treatment services. In addition, youth and the elderly have been identified as groups that may require additional attention from AOD organisations and health professionals. While the COTSA censuses (1990, 1992, 1995, 2001) provide some demographic data on the use of treatment services by Indigenous Australians, females and youth, the data do not address questions of accessibility. Since the COTSA census targets alcohol and other drug treatment

services, and that issues of accessibility for the priority groups were not raised, it is difficult to ascertain on the basis of available information whether any priority groups are currently facing accessibility difficulties for alcohol treatment services.

Summary

The majority of alcohol-related mortality and morbidity comes from low-risk consumers of alcohol who occasionally consume alcohol at high-risk levels (“binge-drinking”). A high proportion of the Australian population regularly drink alcohol at high risk levels. There is some evidence that the prevalence of alcohol dependence is increasing, and gender differences are narrowing due to a greater increase in the prevalence of alcohol dependence among women compared to men. There is a high rate of comorbidity of alcohol or drug problems and mental illness; 20% of individuals with alcohol dependence suffer from an anxiety disorder, and 24% suffer from an affective disorder. Also, 51% of individuals with alcohol dependence are using other drugs, most commonly tobacco or cannabis. Alcohol-related harms can be separated into acute harms resulting from short-term hazardous drinking levels and chronic harms, resulting from long-term hazardous consumption. Acute harms include motorist and fall injuries and pancreatitis. Chronic harms include liver cirrhosis, heart failure and hypertension. Minority ethnic groups, women, youth and the elderly have been identified as priority groups as they may be at elevated risk for alcohol-related harms, and may have special treatment needs for alcohol-related problems. All of the above factors have important implications for workforce development in relation to addressing alcohol-related problems.

Part 2 Current responses to alcohol-related problems

Current responses to alcohol-related problems include inpatient and outpatient treatment, pharmacotherapies, early and brief interventions, and detection and screening. Much of the harm resulting from problematic alcohol consumption is preventable or amenable to treatment (Commonwealth of Australia, 2001). Specialist treatment services and other allied health services frequently respond to alcohol-related problems. Specialist treatment services can respond by providing inpatient and outpatient care, which may or may not include pharmacotherapy. GPs can also prescribe pharmacotherapies, and can provide screening and brief interventions. However, it is estimated that only one in three individuals with an alcohol-related problem receives treatment or is given advice from a health professional (Teesson and Proudfoot, 2001).

Inpatient and outpatient treatment

Information on specialist alcohol and drug treatment services in Australia is available from the Clients of Treatment Service Agencies (COTSA) census (Chen et al., 1992, Shand and Mattick, 2002, Torres et al., 1995, Webster et al., 1990). The 2001 census (Shand and Mattick, 2002) surveyed 507 treatment services Australia wide. The 458 organisations that responded to the census provided a mixture of inpatient and outpatient treatment services. The most common outpatient service provided was counselling, and the most common residential service was inpatient rehabilitation or therapeutic communities. The census shows that 35% of the clients of these services were receiving treatment for alcohol problems, excluding polydrug use. The proportion of clients receiving treatment for alcohol problems has steadily decreased since 1990, when the first COTSA census reported that 55% of clients were being treated for alcohol problems. Holdcraft and Iacono’s study (2002) found that the prevalence of alcohol dependence was increasing in the USA and it is unknown whether a similar pattern may be emerging in Australia. The decrease in the proportion of individuals receiving treatment for alcohol problems

could be partially due to an increase in clients receiving treatment for illicit drugs. The substantial decrease in specialised treatment of alcohol problems raises some serious concerns. In particular, there is reason to assume that a substantial proportion of the population in need of specialist care may not be receiving alcohol-related treatment.

The COTSA census also indicated a trend away from inpatient services. The proportion of individuals with alcohol or drug-related problems receiving outpatient versus inpatient care has increased from 51% in 1990 to 58% in 2001 (Shand and Mattick, 2002). While research suggests that there is little difference in treatment effectiveness between inpatient and outpatient care for most clients, inpatient care is more appropriate than outpatient care in cases of homeless individuals (Proudfoot and Teesson, 2000). A global trend towards reducing the length of inpatient stay for clients with alcohol dependence is also apparent (Bao et al., 2001). Bao, Sauerland and Sturm's (2001) study indicated that the average length of stay for an inpatient receiving treatment for alcohol dependence in Australia had dropped from 10 days in 1987 to less than 6 days in 1996. This finding was in line with trends identified in Canada, Sweden and the United States.

Pharmacotherapy

Pharmacotherapy in the treatment of alcohol problems is an emerging area, and as yet no particular medication has overwhelmingly strong empirical support for its effectiveness. Previously, oral disulfiram (antabuse) has been used to treat alcoholism (Cooney et al., 1995). Disulfiram inhibits enzymes that help break down acetaldehyde in the blood. Acetaldehyde builds up when alcohol is consumed, and causes nausea, vomiting, dizziness and shortness of breath (Proudfoot and Teesson, 2000). Thus, when disulfiram is taken, small amounts of alcohol cause nausea and other unpleasant symptoms. However, research suggests that disulfiram is not an effective treatment, in part due to poor compliance from clients (Cooney et al., 1995).

Several more recent pharmacotherapies have been applied to the treatment of alcohol problems, including naltrexone and acamprosate. Naltrexone and acamprosate aim to prevent relapse into alcohol dependence (Chick, 2001). Naltrexone, an opiate antagonist, has been trialed in the treatment of alcohol problems. Although research on naltrexone is inconsistent and tends to suffer from methodological flaws, there is some evidence of its efficacy (Graham et al., 2002, Proudfoot and Teesson, 2000). The results of naltrexone trials suggest that naltrexone has limited effectiveness, but may help to reduce consumption levels in patients who experience severe cravings, have poor cognitive functioning, or are high risk social drinkers (Proudfoot and Teesson, 2000). Acamprosate, a glutamate antagonist, is seen as the most promising pharmacotherapy, with substantial research supporting its effectiveness, although effect sizes have tended to be modest (Chick, 2001, Graham et al., 2002, Proudfoot and Teesson, 2000). Acamprosate has been supported by more research than naltrexone, involving a greater number of participants and with longer durations of follow-up (Graham et al., 2002).

Studies show that both acamprosate and naltrexone are well-tolerated, with no known serious side effects, and that there is no known interaction effect between alcohol and acamprosate or naltrexone (Graham et al., 2002). Other pharmacotherapies that have received research attention, such as bromocriptine, lithium, ondansetron, selective serotonin reuptake inhibitors and buspirone, have not been shown to be effective treatments for alcohol problems (Graham et al., 2002, Proudfoot and Teesson, 2000).

Brief interventions

Brief interventions are sessions with an individual with an alcohol problem that aim to encourage the individual to change their level of consumption, and are typically assumed to be administered by a general practitioner or other generalist professional (Holmwood, 2002). Bien, Miller and Tonigan (1995) define brief interventions as three or less counselling sessions targeting alcohol consumption. Brief intervention sessions can last for between 5 and 30 minutes and include simple advice coupled with techniques adapted from health education, self-management training, group therapy, social skills training and motivational interviewing (Proudfoot and Teesson, 2000). Bien, Miller and Tonigan (1993) outline six components of effective brief intervention:

- providing feedback of what harms alcohol has caused for the individual, and what risk is involved in continuing excessive consumption
- emphasising the individual's personal responsibility for reducing consumption
- giving clear advice to reduce consumption
- providing a list of alternative strategies or options for reducing consumption
- using an empathic therapeutic style with the individual
- improving the individual's self-efficacy and optimism about reducing consumption.

There is substantial research in the form of trials and meta-analyses that indicates brief interventions are effective (Bien et al., 1993, Cooney et al., 1995, Wilk et al., 1997). Brief interventions have been found to produce the greatest effect in individuals with mild to moderate problems with alcohol (Wilk et al., 1997). Wilk, Jensen and Havighurst (1997) analysed 12 randomised controlled trials of brief interventions and found heavy drinkers were twice as likely to lower their consumption six to 12 months after a brief intervention than heavy drinkers who received no intervention. A recent long-term follow-up indicated that the reduction in levels of alcohol consumption following brief intervention reduces health care utilisation and consequently reduces costs associated with treating the individual with an alcohol-related problem (Fleming et al., 2002). However, brief interventions appear to be less effective for women (Proudfoot and Teesson, 2000).

Brief interventions can also be conducted by correspondence (Sitharthan and Kavanagh, 1996). Correspondence methods of intervening were developed in order to provide an alternative method of intervention. Sitharthan and Kavanagh (1996) found that sending letters detailing the effects of alcohol, encouraging self-monitoring of consumption and providing cognitive-behavioural strategies for reducing consumption to individuals who had been identified as having a low level of alcohol dependence had a beneficial effect on levels of alcohol consumption and reduced weekly alcohol consumption by over 50%. Cognitive-behavioural interventions conducted by correspondence may be a very cost-efficient, effective means of brief intervention for individuals with alcohol-related problems. Correspondence was found to be equally effective for individuals with different degrees of alcohol dependence or alcohol problems (Kavanagh et al., 1996).

Detection and screening

The role of detection in treatment and referral to specialist alcohol services has been emphasised in the literature (Paton, 1996). Paton (1996) argues that "If we are serious about reducing harm, this must be a priority." General practitioners are often the first source of medical aid for people with alcohol problems (Farmer and Greenwood, 2001) and are well placed to identify and intervene in alcohol problems (Durand, 1994, Roche et al., 2002). Nurses are also believed to be well positioned to provide early detection of drug and alcohol related problems (Norman,

2001) particularly as it has been estimated that up to 30% of hospital admissions are related to hazardous alcohol consumption (Roche and Richard, 1991).

There are several methods of screening individuals for hazardous alcohol consumption or alcohol dependence. Clinical examinations can be used to assess for signs of excessive alcohol consumption, such as dilated facial capillaries and hand tremor. Alternatively, biological markers can be used, such as the liver enzyme GGT, or blood, breath, saliva or urine alcohol levels can be taken as a measure of current excessive drinking (Cooney et al., 1995, Proudfoot and Teesson, 2000). However, a more efficient way of screening for alcohol problems has been developed through the use of screening tools (Hodgson et al., 2002). These are brief measures of alcohol consumption and issues relating to alcohol consumption that can be completed in short consultations, and can then allow the health professional to provide a brief intervention, or to refer the individual on to a more specialised service.

The most widely used screening tools are the Alcohol Use Disorders Identification Test (AUDIT), CAGE and Michigan Alcoholism Screening Test (MAST) questionnaires (Proudfoot and Teesson, 2000). The screening measures can be conducted face to face, with pen and paper, or on a computer (Cooney et al., 1995). AUDIT was developed by the World Health Organization and is a 10-item measure of hazardous consumption and dependence (Saunders et al., 1993). Research supports using the AUDIT over other questionnaires because it has a greater sensitivity to alcohol problems, and has more relevance, as it concerns recent drinking patterns rather than lifetime patterns (Hodgson et al., 2002, Proudfoot and Teesson, 2000). AUDIT is an accurate predictor of future alcohol-related harm, including illness, hospitalisation and social problems (Conigrave et al., 1995).

More recently, shorter versions of the AUDIT have been developed, such as the 4-item measure FAST, which has a sensitivity greater than 90% for alcohol problems (Hodgson et al., 2002). The main advantage of the FAST is that one question ('How often do you have eight or more drinks in one occasion?' for men and 'How often do you have six or more drinks in one occasion?' for women) can act as a filter for further questions. Individuals who answer 'never' are categorised as non-hazardous drinkers, while individuals who respond with 'weekly' or 'daily or almost daily' are categorised as hazardous drinkers. Hence, the FAST can categorise over 50% of individuals with an accuracy of over 95% based on the first question alone. Individuals who respond with 'less than monthly' or 'monthly' (approximately one third of individuals) need to be asked the three further questions. This single-item filter has great appeal considering the time constraints experienced by health professionals when screening for alcohol problems. Williams and Vinson (2001) have also developed a single question screening tool for hazardous drinking. The question, "When was the last time you had more than X drinks in 1 day?" where X=5 for men and X=4 for women, has a sensitivity of 86% and a specificity of 86%. These new screening tools augur well for expanded activity in this area.

Barriers to GP intervention and screening

Despite the emphasis on detection in the literature, research has shown that general practitioners and other health professionals rarely question individuals about their alcohol consumption (Weller et al., 1992). Factors affecting GPs' willingness to screen patients include a fear of losing patients (Weller et al., 1992), finding it difficult to raise the topic (Mowbray and Kessel, 1986, Weller et al., 1992), having negative attitudes towards individuals with alcohol problems (Farmer and Greenwood, 2001), not having the time during consultations (Mowbray and Kessel, 1986, Weller et al., 1992) and feeling that there is nothing the professional could do for the person anyway (Farmer and Greenwood, 2001, Weller et al., 1992). Research indicates that GPs tend to have little confidence in the effectiveness of treatments for alcohol problems (e.g. Abouyanni et al., 2000, Roche et al., 1995b, Roche et al., 1996). Low numbers of GP trainees

have been shown to support treatments such as antabuse (13%), cognitive behavioural therapy (31%) and inpatient rehabilitation programs (58%) (Roche et al., 1995b). Wechsler and Rohman (1982) found 18% of medical students did not believe any of the major treatments for alcoholism were very good. There also appears to be considerable doubt over the efficacy of brief advice to patients (Roche et al., 1995b) and early intervention strategies for alcohol or other drug problems (Roche et al., 1995a).

GPs and other members of the workforce dealing with alcohol-related problems may lack feelings of role adequacy, role legitimacy and role support (Dwyer, 1995). Shaw, Cartwright, Spratley and Harwin (1978) developed a theory of therapeutic commitment to clients with alcohol-related problems. According to this model (summarised in Figure 3), therapeutic commitment is negatively associated with high role insecurity. Role insecurity is theorised to be a complex phenomenon involving intellectual (inadequate training and knowledge), situational (perceived situational constraints and barriers) and emotional (feeling emotionally unprepared) dimensions. Role insecurity is a combination of low role adequacy (feeling untrained or unskilled), low role legitimacy (feeling it is not appropriate to intervene) and low role support (perception that support and help that would enable effective intervention is not available).

Figure 3: Shaw et al.'s (1978) Model of Therapeutic Commitment.

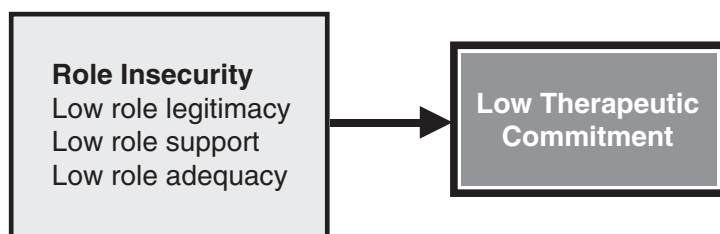

If members of the workforce have feelings of low role adequacy, low role legitimacy and low role support, then their ability to effectively intervene in alcohol-related problems is diminished. This can result in staff avoiding screening or treating individuals with alcohol-related problems or offering a poorer quality of service (Shaw et al., 1978). Role legitimacy, role support and role adequacy have been shown to be related to the number of clients with alcohol-related problems with whom GPs engage (Clement, 1986, Bush and Williams, 1988). Questions arise regarding what strategies can be effectively employed to reduce feelings of role insecurity and enhance levels of therapeutic commitment.

Summary

There are several treatment and prevention strategies that have been developed for high-risk or dependent alcohol consumption. There is an international trend towards outpatient treatment for alcohol-related problems, rather than inpatient treatment, and a reduction in the length of stay for individuals undergoing inpatient treatment. Naltrexone and acamprosate are new pharmacotherapies that are designed to prevent relapse in individuals who are undergoing treatment for alcohol dependence. Trials suggest that acamprosate has reasonable effectiveness, while naltrexone may be useful among individuals who experience severe cravings, have poor cognitive functioning, or are social, high-risk consumers. Brief interventions are counselling sessions aimed at reducing an individual's level of consumption. Brief interventions have been found to result in a reduction in consumption of alcohol, and can be done face to face or through correspondence. Screening tools, such as the AUDIT and the FAST, are quick and sensitive measures for hazardous or dependent alcohol consumption, and facilitate brief

intervention or referral. However, attitudinal barriers to screening and intervention by GPs have been noted in the literature together with generally low levels of activity in this area. Role insecurity can lead to a lack of therapeutic commitment among GPs and a low willingness to intervene in alcohol-related problems. While a wide range of treatment and intervention options exist there is strong evidence that effective strategies are largely under-utilised. Various factors contribute to the less than optimal level of use of available intervention options.

Part 3 Who should respond to alcohol-related problems?

The diverse range of professionals that comprise the alcohol workforce can be broadly divided into specialist and generalist workers. Different professions are positioned to provide different, complimentary responses to alcohol-related problems.

The alcohol workforce

Given the diverse and heterogeneous range of problems associated with excessive alcohol consumption (including health problems resulting from acute or chronic consumption, and associated social and legal problems), an equally heterogeneous workforce is needed in order to reduce alcohol-related harm. A variety of professions come into contact with individuals with alcohol-related problems, and are in a position to offer treatment or otherwise reduce the harm that alcohol causes (Ask et al., 1998). Several recent reports have examined the different professions that deal with alcohol or other drug related problems (Ask et al., 1998, Community Drug Summit, 2001). A study by the National Centre for Education and Training on Addiction (Ask et al., 1998) identified three key factors in their definition of AOD frontline professionals. According to this definition, frontline professions are groups that:

- are likely to intervene in alcohol or drug related problems
- have a client base with a prevalence of alcohol or drug related problems
- have significant potential to have an impact on alcohol or drug-related harm.

NCETA surveyed 21 key informants who had extensive experience in education and training in the field of alcohol and other drugs, and who were well-placed to provide accurate information on professions dealing with alcohol and other drug related problems (Ask et al., 1998). The results of the survey identified a wide range of professionals who may be classified as frontline workers.

In the medical and allied health field, these professionals included:

- general practitioners and other medical professionals
- nurses
- social workers
- psychologists
- counsellors
- occupational therapists
- youth workers
- crisis care workers
- ambulance officers
- pharmacists
- general welfare workers and ethno-specific welfare workers

- health workers responding to problems among indigenous people
- drug specialist workers.

In the area of education they included:

- school counsellors
- teachers.

In the field of law enforcement they included:

- police
- correctional workers
- prison and community officers
- magistrates
- judges.

However, NCETA's survey, as with other surveys such as COTSA (Chen et al., 1992, Shand and Mattick, 2002, Torres et al., 1995, Webster et al., 1990), targets the alcohol and other drugs field rather than alcohol specifically. Since no Australian research has focused solely on frontline professions for alcohol-related problems, the roles of the identified professions in responding to alcohol-related problems remain unclear.

Specialist and generalist workers

Professions involved in responding to alcohol or drug related problems can be classified as specialist or generalist (Ask et al., 1998). Specialist workers respond to alcohol-related problems within a specific alcohol or other drug (AOD) service (for example, psychologists or social workers who work in alcohol or drug treatment services). In contrast, a generalist worker may be required to respond to alcohol-related problems, but does not work in a specific AOD setting (for example, nurses and general practitioners). Hence, specialist and generalist workers' roles in the treatment of alcohol-related problems may be very different.

There is debate regarding the roles of specialist and generalist professionals in intervening in alcohol problems (Roche, 1998, Chick, 2001). For some time it has been argued that generalist workers have a major role in the treatment of alcohol-related problems (Roche and Richard, 1991, Durand, 1994, Farmer and Greenwood, 2001). The move towards inclusion of generalist workers is in part due to the movement away from the traditional disease model of alcohol dependence (Institute of Medicine, 1990). According to the disease model, alcohol dependence is a disease that is best treated by a specialist physician (Chick, 2001). More recent theories conceptualise dependence as being at one end of a continuum of drinking patterns (Chick, 2001). Hazardous, or high-risk levels of consumption have been emphasised as a more widespread health issue (Roche, 1999). This has broadened the focus of care to include the prevention of alcohol-related problems and the minimisation of acute harm resulting from hazardous patterns of drinking (Chick, 2001). Generalist health workers are well placed to respond at this level (Chick, 2001).

It has become apparent that specialist workers can not be the sole responders to alcohol and other drug problems. However, specialist workers may be more appropriate to treat individuals dependent on alcohol, as one advantage of specialist treatment over generalist treatment is the greater period of time available to the specialist workers to engage, counsel and treat the client's alcohol or drug related problems (Ask et al., 1998). Also, more recent interventions in alcohol problems, such as the new pharmacotherapies, require specialised, technical knowledge, and thus are more suited to specialist intervention. A summary of potential alcohol-related harms,

appropriate treatment or prevention strategies and indicative workforce response categories is shown in Table 3.

Table 3: Alcohol-related harms and appropriate treatment or prevention strategies and corresponding workforce responses.

Category of Harm	Example	Appropriate treatment or prevention	Workforce response*
Acute Harm			
Injuries related to hazardous consumption	Fall injuries, motorist injuries	Prevention and/or early intervention	e.g. teachers, police, bar staff
Illnesses resulting from hazardous consumption	Acute pancreatitis, alcoholic beverage poisoning	Brief intervention with individuals identified as drinking at hazardous	e.g. GPs, practice nurses, counsellors
Chronic Harm			
Illnesses resulting from chronic consumption of alcohol	Liver cirrhosis, oesophageal varices	Medical treatment	e.g. specialist medical and nursing workforce
Alcohol dependence and withdrawal		Specialist addiction treatment	e.g. specialist addiction workforce, counsellors

* Professions in the workforce response categories are intended to be indicative of potential responding professionals rather than an exhaustive list.

Unfortunately, while there is substantial research on responses to alcohol-related problems, little information is available on the specialist alcohol workforce in Australia, including information about qualifications (Hornblow, 2002, Ask et al., 1998). It is estimated that one third of specialist drug and alcohol workers do not hold relevant qualifications (Ask et al., 1998). In a comparable Canadian study (Ogborne et al., 2001), researchers found that among specialist drug and alcohol counsellors or other staff, 25% had a certificate or diploma in addiction studies, or were studying to obtain one, and only 12% were certified as alcohol or drug treatment counsellors. The United States has a formal accreditation system for addiction specialists, allowing assessment of the number of addiction specialists in different health professions. From this data, 4% of primary care professionals, 4% of psychiatrists, 2% of nurses and 10% of social workers have specialised in addiction (Keller and Dermatis, 1999). Since no formal accreditation process exists in Australia, there are no comparable statistics (Roche, 2001).

Roche (1998) provides a classification of professions responding to alcohol and other drug (AOD) related problems based on the training and other needs of specialist and generalist professionals and other workers. An overview of this classification is given in Table 4.

Generalist health professionals are categorised as A1, while groups A2 and B1 are the specialist alcohol and other drug workers. Groups C1 and C2 comprise of the other professionals that come into contact with individuals with alcohol-related problems in the course of their work. Roche (1998) notes that the specialist, unqualified workforce (Group B1) have the most difficult education and training needs to meet, while accredited short courses could meet the needs of groups A1 and C1.

Table 4: Classification of frontline professions (from Roche, 1998).

Title	Description
Group A	
A1. Non-AOD health professionals	Non-AOD health professionals, e.g. doctors, nurses, social workers, psychologists and so on with no particular training or background in AOD.
A2. AOD-specialist health professionals	Specialist professionals such as psychologists, counsellors, psychiatrists, public health physicians and so on who have a particular interest in the alcohol and drug field.
Group B	
B1. Alcohol and drug workers	These are the alcohol and drug workers who do not usually have a particular professional qualification, and may not have a high level of basic education (which can thus make the acquisition of further education and training difficult by not being able to fulfil entry requirements for tertiary level courses), but who may have substantial personal experience with alcohol and/or drugs.
Group C	
C1. Non-health professionals	Non-health professionals may come from very varied professional backgrounds (eg police, teachers, and probation officers) with varying levels of professional education and training within their basic profession.
C2. Non-health AOD specialists	These might include teachers, criminal justice system personnel, economists with a specialist interest in alcohol and other drugs
Group D	
D1. Volunteers	Volunteers are increasingly engaged within the alcohol and drug field and have varied backgrounds with varying levels of education and training and work experience. Volunteers play an important part in the delivery of alcohol and drug services and have special education and training needs.

Rural professionals

The NCETA survey of frontline professions (Ask et al., 1998) noted that rural and regional workers may need special attention, as this group is cut off from the main support network of the metropolitan health system, and face higher rates of turnover. The isolation of rural health professionals causes problems with transportation, understaffing and opportunities for supervision (Ask et al., 1998). Rural health professionals also have less access to training and support (Bush and Williams, 1988). Bush and Williams (1988) found that while 100% of urban generalists had received some form of formal alcohol training, only 39% of rural generalists had undergone alcohol studies, and those who did had done so in cities. Unsurprisingly then, research shows that rural generalists tend to be less skilled and less qualified in AOD issues than metropolitan generalists (Ask et al., 1998, Bush and Williams, 1988). Ask et al. (1998) suggest open learning techniques as a possible solution to the lack of training opportunities, but acknowledge rural health professionals’ lack of time and resources as a significant barrier.

Other professionals

Roles for other workers identified as frontline professionals have also been outlined in the literature. Teachers are seen as having a substantial role intervening with youths who are consuming alcohol (Midford and McBride, 2001). There has been increasing pressure on teachers to develop and implement alcohol prevention programs and to identify children that may have alcohol-related problems, or come from homes with alcohol-related problems (Midford and McBride, 2001). The importance of teachers' roles in identifying alcohol-related problems is reinforced by the recognition that youth are particularly susceptible to alcohol-related problems (Roche and Watt, 1999) and the finding that the average age that youth begin drinking alcohol is 13 (Ask et al., 1998). Documents such as "Principles for drug education in schools" (Ballard et al., 1994) have been developed in order to aid teachers to provide this education.

Professions involved in licensed venues such as bars and clubs are also in a position to lower alcohol-related harm (Graham and Homel, 1997, Norton, 1998). Licensed venues have been found to increase the likelihood of heavy drinking, drink-driving and alcohol-related aggression (Graham and Homel, 1997). An assessment of offences in New South Wales found that 77% of street offences (such as assault or offensive language or behaviour) involved alcohol, and 60% occurred in or near a licensed venue (Ireland and Thommeny, 1993). In particular, smoky or crowded bars, or bars with poor ventilation, inadequate seating or high noise levels have been associated with higher rates of aggression among patrons (Graham and Homel, 1997). It is theorised that such conditions irritate or frustrate patrons, which increases the likelihood of alcohol-fuelled aggression (Graham and Homel, 1997). Supporting this theory, alcohol has been found not to increase aggression in neutral settings, but in settings evoking frustration or provoking aggression, alcohol was associated with higher rates of aggression (Graham and Homel, 1997). Crowding is especially a problem in bars with a poorly designed layout where intersecting traffic flows caused by inconvenient access to bars, toilets and exits can increase the frustration of patrons (Graham and Homel, 1997). Other factors contributing to alcohol-related harm include poor lighting, the placement of furniture and other physical hazards (Doherty and Roche, 2002).

Managers of licensed venues could reduce alcohol-related harm by controlling the factors that promote alcohol-related aggression or harm. Controlling the number of patrons in the venue, ensuring convenient layout of the facilities, providing adequate ventilation and lighting, minimising any physical hazards and keeping noise levels tolerable may help to reduce alcohol-related harm (Doherty and Roche, 2002, Graham and Homel, 1997). Other initiatives for venue managers that have been suggested include using tempered glass for glassware to reduce the likelihood of glasses being used as weapons in aggressive incidents, and the provision of food (Graham and Homel, 1997). The consumption of food slows the absorption of alcohol, lowering patrons' blood alcohol content, and is also believed to attract less aggressive patrons, and alter the atmosphere of the venue by shifting the focus away from the consumption of alcohol. Initiatives such as reducing overcrowding and discouraging sales to intoxicated patrons were identified as a key strategy area by the National Alcohol Strategy (Commonwealth of Australia, 2001).

Perhaps the most important strategy to reduce alcohol-related harm in and around licensed venues is to discourage drinking to intoxication by promoting the responsible service of alcohol among bar staff (Graham and Homel, 1997, Norton, 1998). Industry codes of practice have addressed this issue (Doherty and Roche, 2002), but are hampered by difficulties in defining and assessing intoxication systematically and fairly (Norton, 1998). Donnelly and Briscoe (2002) found very low compliance rates with the standards of responsible service of alcohol.

Of 230 individuals displaying at least one sign of intoxication (loss of coordination, slurred speech, being loud or quarrelsome, spilling drinks or staggering or falling over), only 5 (2%) were refused more alcoholic drinks, and 55% were served more alcoholic drinks.

As Ireland and Thommeny's (1993) study of alcohol-related offences suggests, police also have substantial contact with individuals with alcohol-related problems or who consume alcohol at high-risk levels. Police can also reduce alcohol-related harms, as the enforcement of legislation concerning alcohol provision can contribute to lower rates of drinking to intoxication in licensed venues (Doherty and Roche, 2002). Research shows that police contributions to the prevention of alcohol-related problems can be effective (Spooner and McPherson, 2001). Hence, police have also been targeted for education and training on alcohol and drug-related problems (Fowler et al., 1999). Involvement of the police in alcohol and drug-related problems includes collaborative initiatives between health and police, such as needle exchange services (Ask et al., 1998). There has been increasing emphasis on educating police about alcohol and drug problems in order to promote harm minimisation strategies in policing alcohol and drug offences, such as the policing of licensed venues (Fowler et al., 1999).

Summary

A wide range of professions have been identified who encounter individuals with alcohol-related problems as part of their day to day work. Specialist workers and generalist health professionals play key roles in reducing alcohol-related harm. Specialist workers aim to treat and alleviate chronic harm through providing intensive and on-going treatment services. There is little information on the make up of the specialist alcohol workforce in Australia, although NCETA has provided one estimate based on a survey of AOD specialist treatment services. Generalist health professionals work towards preventing alcohol-related harm by screening patients and providing brief interventions. Rural health professions responding to alcohol-related problems have been found to face additional difficulties such as reduced accessibility to training and support. Other professions, such as teachers, bar managers, bar staff, and police also play important roles in responding to alcohol-related problems and minimising harm. However, evidence suggests that these roles are less than fully utilised in this area.

Part 4 What are the workforce development issues in responding to alcohol related problems?

The prevention and treatment of alcohol-related problems involves a multitude of workforce development issues. There are a wide variety of workforce development strategies that can be employed to improve the alcohol workforce's response to alcohol-related problems.

Workforce development

The multitude of systemic factors that influence responses to alcohol or drug related problems has prompted a focus on 'workforce development' (Roche, 2001). Central goals of workforce development are to build the capacities of organisations and individuals to respond to alcohol or drug related problems, and to promote evidence-based practice in the AOD field. Workforce development incorporates organisational and systemic initiatives to increase the knowledge and skills of both specialist and generalist workers, and includes strategies such as supervision and partnerships. Even though the health workforce is the major cost component in health expenditure, few countries have developed a strategic approach to workforce development (Hornblow, 2002).

In many countries, market factors were relied upon to facilitate workforce development. However, commercial interests focused on efficiency and profit rather than workforce development, resulting in an absence of workforce planning (Hornblow, 2002). Also, the relatively recent shift away from purely hospital-based care has been accompanied by little attention on the new skills required in population-based prevention strategies. Consequently, there is an urgent need for planned, structured workforce development in the alcohol workforce. Workforce development can be conceptualised as a four-stage process (see Figure 4).

Figure 4: De Geyndt's Framework of workforce development for the health workforce

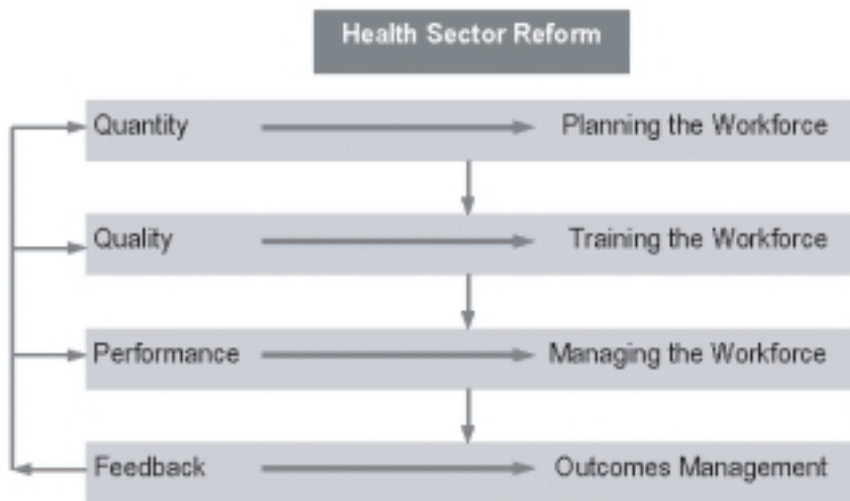

(from Hornblow, 2002)

According to De Geyndt's framework, the most important components of workforce development are planning the workforce, providing adequate training for the workforce, managing the workforce in a manner which maximises the workforce's performance, and evaluating feedback from outcomes (Hornblow, 2002). From De Geyndt's model, workforce development is central to health planning and strategic reform of health care (Hornblow, 2002). It is unlikely that market forces will achieve the level of health care reform that is needed. Instead, the responsibility needs to rest with the public sector to ensure reform. Workforce development needs can be divided into the needs of health professions and the needs of the health system (Hornblow, 2002). The needs of the health professional include training and on-going education and career development and performance monitoring. The needs of the health system include recruitment and retention, workload management, risk management and operational decision-making.

Workforce development strategies

Specific workforce development strategies include education and training, supervision, partnerships, and active dissemination of research findings.

Education and training

Education and training has been identified as one of the greatest areas of concern in the alcohol and drug field (Roche, 1998). Roche (1998) differentiates education from training, defining education as an examination of knowledge and theoretical approaches, and training as the

transfer of specific skills. There has been substantial pressure to standardise education, training and qualifications for specialist workers. Education and training has been found to be highly variable in nature, content and quality, and there are concerns that some education is unstructured and ad hoc (National Centre for Education and Training on Addiction, 1998). Also, the lack of knowledge of specialist worker's education and qualifications, and the estimated low rate of formal qualifications in the field has caused concern (National Centre for Education and Training on Addiction, 1998, Roche, 2001). NCETA reports have consistently emphasised the need to provide structured education and training to specialist workers to ensure consistent quality and to cover existing gaps in knowledge and skills.

As Roche's (1998) classification of the AOD workforce shows (see Table 4), different professionals in the workforce have different education and training needs. There has been significant pressure to extend basic AOD training to the generalist workforce (those identified as A1, C1 or C2 professionals), in order to include professionals such as GPs, nurses, pharmacists, teachers and probation officers (Roche, 1998). Such training would ensure generalist workers have the skills to identify and initially respond to alcohol-related problems, and refer the individual on to a more specialised service (Roche, 1998). Education and training could be provided to generalist workers at different levels: during basic training, by incorporating AOD education in undergraduate topics, post basic training, by offering accredited tertiary courses, and through the provision of short courses that allow on-going education for health professionals (Roche, 1998). The priority education and training is receiving is highlighted by the growing literature on what should be included in training, how to deliver the training, and how to evaluate the effectiveness of the training (cf. Ask et al., 1998, Roche, 1998, O'Donovan and Dawe, 2002). Ask and colleagues (1998) identified possible methods and goals of education and training for alcohol and drug specialist workers as well as a range of other professions, including medical doctors, nurses, psychiatrists, ambulance officers, social workers, teachers, pharmacists, police and magistrates.

The high rate of comorbidity for alcohol or drug problems and mental illness raises concerns for the training of AOD specialists. Some maintain that it does not seem possible to provide AOD workers with enough training in mental health to provide adequate holistic treatment for the client with alcohol or drug problems and a mental illness (Saunders and Robinson, 2002). Mental health is a complex speciality that usually requires two to five years additional training for doctors, nurses or psychologists, and it may not be possible to develop brief training programs suitable for AOD workers (Saunders and Robinson, 2002). Ask and colleagues (1998) have argued that professionals such as psychiatrists could receive education and training about alcohol and drug problems. This may allow psychiatrists to treat individuals with mental illness and alcohol or drug problems in a more holistic and beneficial manner (Ask et al., 1998).

Supervision and partnerships

Kavanagh, Spence, Wilson and Crow (2002) argue that the seldom-used practice of supervision in the AOD field may provide further benefits to the alcohol workforce. Kavanagh et al. (2002) defined supervision as primarily an alliance between members of the workforce to enhance clinical practice, fulfil the goals of the organisation and to meet the standards of the organisation and profession. Research suggests that effective supervision can help the transference of complex, clinical skills to members of the workforce, and increase workers' job satisfaction and morale (Kavanagh et al., 2002). Since workers' lack of confidence in their skills to treat individuals with alcohol-related problems has been identified as a barrier to effective treatment (Shaw et al., 1978), increasing these skills and increasing job satisfaction would increase the quality of treatment provided to individuals with alcohol-related problems, and also workers' willingness to treat these individuals.

Partnerships between AOD organisations may also facilitate improvement in the treatment of alcohol-related problems (Wilkinson et al., 2002). Partnerships foster cooperation between AOD organisations and the transfer of skills and knowledge among workers (Wilkinson et al., 2002). Through partnerships, organisations can also collaborate on strategies to increase and improve the provision of services to individuals with alcohol or drug related problems. However, Wilkinson, Browne and Dwyer (2002) note that one barrier to the implementation of effective partnerships is that such collaboration can require time, effort and resources beyond organisations' capacities, especially for the initial development of partnerships. Wilkinson, Browne and Dwyer (2002) identified several factors that could facilitate the development of a successful partnership, including:

- open lines of communication between the organisations
- an assessment of shared goals of the organisations
- thorough planning of the collaboration
- an evaluation of resource needs
- measurable outcome goals of the partnership so that the results of the partnership can be evaluated.

Dissemination of research findings

Research is an important factor in increasing the skills and knowledge of the alcohol workforce. The National Alcohol Research Agenda (National Drug Strategy, 2002) identified several areas of research as a high priority for the alcohol field, including the acute and chronic harms associated with alcohol consumption, interventions for alcohol-related problems, community-based prevention and prevention through public policy and health. However, research suggests that dissemination of research findings is often inadequate (Richmond, 1996, Roche, 2001). Richmond (1996) identified several researcher and practitioner barriers to effective dissemination based on previous research. Practitioners may be unaware of the research findings because they have not read the relevant literature, or practitioners may prefer to maintain current practices rather than try a new treatment approach. Time and effort constraints, and a lack of opportunities for training are also disincentives to adopting new treatment approaches. Researchers may fail to present their research findings in a readable manner, or fail to actively inform policy makers or practitioners of their findings. Research reports tend to be printed in journals likely to be read only by researchers, and after a lengthy delay.

Richmond (1996) argues that a suitable forum is needed to promote discussion between researchers, policy makers and practitioners. Other recommendations include presentation of findings in a clear and meaningful manner for dissemination, providing copies of the findings to teachers in tertiary institutions, publishing relevant sections of the results in journals or newsletters read by practitioners and policy makers, or the dissemination of pamphlets summarising the findings. Richmond (1996) also emphasises the need for follow-up assessments to evaluate the success of the dissemination. One answer to the problems surrounding dissemination is the Drugs and Alcohol Cochrane Review Group (White, 2001). This group focuses on providing clear, systematic reviews of literature on different topics in the AOD field. One example of such a review is a meta-analysis of literature on opioid antagonists for alcohol dependence. The Cochrane reviews are disseminated in three ways (White, 2001). A brief summary in plain language is distributed to consumers and non-specialist professionals, and an abstract of the technical report and copies of the full review are made available to specialist workers. Without Cochrane reviews and other dissemination strategies, frontline professions are likely to maintain existing approaches rather than applying newer, more effective treatment, prevention and intervention strategies.

Summary

Workforce development incorporates a range of systemic factors that influence workforce responses to alcohol-related problems. Workforce development is integral to health care reform, and market forces can not adequately achieve this reform. Possible strategies include education and training, supervision and partnerships between AOD organisations. Different professions in the alcohol workforce have different education and training needs, which may require a combination of short courses, basic training and accredited tertiary courses. Comorbidity for alcohol or drug problems and mental illness raises concerns for education and training for the alcohol workforce, as mental illness is regarded as a specialisation that can not be adequately covered in a brief training program. Dissemination of research findings could also be improved in order to increase the knowledge base of the alcohol workforce. The Cochrane reviews provide user-friendly analyses of recent research that health professionals can access and employ.

Conclusion

A significant proportion of the population is consuming alcohol at medium or high-risk levels for acute or chronic harms. These harms can include injuries, cancer and stroke, as well as a range of social and interpersonal harms. Particular groups within the community are at elevated risk of experiencing alcohol-related harms. These groups include young people under the age of 25 years, women and especially young women, Indigenous Australians, elderly people and those of ethnic minority groups.

A wide range of professions come into contact with individuals with alcohol problems as part of their work, including specialist and generalist health professionals, and other professions such as police, teachers, and bar staff. Specialist workers can provide intensive treatment for individuals with alcohol-problems, while generalist workers such as GPs are well positioned to screen individuals for alcohol problems and provide brief interventions. Effective brief interventions can also be conducted through correspondence. Screening individuals in primary care for alcohol-related problems can facilitate brief interventions or referral to specialised treatment. Short, accurate screening tools such as the AUDIT and the FAST have been developed which allow quick assessment of alcohol-related problems.

Workforce development is an emerging and pivotal issue in addressing alcohol-related problems. Substantial attention is required in order to overcome barriers to effective intervention in alcohol-related problems and to facilitate acquisition of new skills and knowledge. Workforce development includes effective strategies such as education and training, supervision, organisational support, partnerships and active dissemination of research findings. To date, workforce development has received comparatively little attention from the AOD field. However, in the past one to two years it has been increasingly acknowledged by governments and service providers alike that workforce development is central to achieving substantial progress in preventing and managing alcohol-related problems.

This review highlights the prevalence of alcohol consumption in Australia. It addresses patterns, responses and workforce development issues that relate directly to alcohol. It also reinforces the notion that the misuse of alcohol is a major public health problem in Australia that goes largely unnoticed in comparison to the attention focussed on illicit drugs. The review raises many questions and highlights shortfalls in the research and knowledge base of the AOD sector's response to alcohol-related problems.

Specific gaps in the literature were also found in relation to information about the size, composition and education and training of the AOD workforce. There is also a lack of research

that addresses workforce development issues from a frontline worker's perspective. It is evident from this review that further investigation is needed into the capacity of the AOD workforce in general, and specifically its capacity to cater for priority groups and polydrug using clients with alcohol-related problems. To address these issues a national scoping survey of AOD specialist treatment services was undertaken to obtain information on the nature of agencies, current and emerging service provision for alcohol-related problems, composition of the workforce and workforce development issues in general.

Methodology

Sampling frame

The 2001 version of the Clients of Treatment Service Agencies (COTSA) database was used to identify specialist alcohol and other drug treatment agencies to be contacted for the managers' telephone survey. COTSA defined an AOD service in the following way:

“To be identified as a drug and alcohol treatment service an agency should provide one or more face to face specialist treatment services to people with an alcohol and/or other drug problem, including among others a variety of outpatient treatment services, inpatient rehabilitation programs, detoxification, therapeutic communities, methadone maintenance plus an additional service, and smoking cessation programs.

Using this definition, self help groups, sobering up centres, and services that only provide counselling and crisis interventions were not classified as specialist treatment agencies and therefore, were not included.”

(Torres et al., 1995)

The 2001 COTSA database listed the contact details of 549 treatment agencies across Australia. The database was used as the sampling frame for this study.

Agency post code details were coded into metropolitan and non-metropolitan areas according to the Australia Post Print Post Sort Plans (www.auspost.com.au/postcodes/).

Ethics approval

Ethics approval for the project was obtained in March 2002 from the Flinders University Social and Behavioural Research Ethics Committee.

Survey instrument

A purpose-designed survey instrument was developed for telephone interviews with managers of specialist alcohol and other drug (AOD) treatment agencies. The interview schedule was highly structured with a mix of quantitative and qualitative questions. It contained 59 items (including 14 sub items) and was designed to be completed within 15-20 minutes. A copy of the survey instrument is attached as Appendix A.

The survey instrument was designed in four sections to obtain information about: the agency, the workforce, workforce development issues and demographic information. Details of each section follow.

Section 1: The agency

The first section of the questionnaire (items 1.1 – 1.9) examined the type of service the agency provided, its client base, treatment approach and funding adequacy.

Section 2: The workforce

Section two (items 2.1 – 2.19) sought information about the number of staff the agency employed and the number working directly with people experiencing problems related to their use of alcohol and other drugs. It also aimed to determine whether the agency had staff who dealt only with the treatment and management of clients with alcohol problems.

Section 3: Workforce development issues

Section three (items 3.1 – 3.7) identified issues that may enhance or hinder workforce development within the agency. It also aimed to identify staff development and training needs, and issues related to staff recruitment and retention.

Section 4: Demographics

Section four (items 4.1 – 4.11) covered demographic information on the managers' age, gender, background, education and training, and time spent in the alcohol and drug field.

Pilot study

Before commencing the main study a comprehensive pilot study was undertaken from 18 February to 8 March 2002. The pilot study was designed to test the appropriateness of the telephone survey instrument developed for the project and to trial the proposed methodology. A sub sample of 20 agencies was selected from the COTSA database. These 20 agencies provided a cross section of managers, reflecting the different types of agencies providing alcohol and other drug treatment services. The pilot study included participants from all states and territories. A total of 20 pilot telephone interviews were completed. Following the pilot study the survey instrument was refined to manage time limitations and improve clarity.

Study implementation

Following the pilot, the main study commenced in April 2002. The initial implementation of the study involved a mailout of two letters to all 549 treatment agencies listed on the COTSA database.

The first letter, a letter of introduction, informed managers of the study which was about to be undertaken. This letter explained the project, invited managers to participate in the study and assured confidentiality. A second letter, mailed to all managers a few weeks later, was a recruitment letter that invited managers to participate in the study and asking them to contact project staff to arrange a convenient time for a telephone interview.

It was planned that these letters would be mailed out to different states sequentially so project staff could manage interview appointment times. The letter of recruitment was sent to managers located in SA and ACT on 15 April 2002, and to managers in NSW two weeks later on 26 April 2002.

The response to recruitment letters was slow. To keep the project on the planned timeline, the methodology was modified and recruitment letters were sent to managers in all remaining states on 21 May 2002 in an attempt to increase response rate. The response from managers continued to be slow. The recruitment strategy was then supplemented with an online initiative.

Details of the survey were posted on the Alcohol and Other Drugs Council of Australia's (ADCA) Update list server, to further encourage managers to contact project staff and arrange an interview time. The survey instrument was also placed on the NCETA website where it could be completed and returned online. The online version of the survey was reformatted for electronic distribution but otherwise remained identical to the survey presented in Appendix A.

To encourage participation in the project, managers were offered incentives of a free copy of the Mentoring Monograph published by NCETA and an opportunity to win a free registration to the Australian Professional Society on Alcohol and Other Drugs (APSAD) Conference held in Adelaide 18–20 November 2002.

The most effective means of contact and recruitment was the use of follow-up phone calls to managers. Personal telephone calls inviting managers to participate were received favourably. The managers who were contacted in this manner frequently nominated a time for an interview. However this strategy was time consuming, requiring several follow-up telephone calls, as managers were frequently difficult to contact.

Agency contact details listed on the COTSA database were sometimes found to be out of date due to factors such as agency relocation or rationalisation. These details have been updated on the NCETA 2002 version of the COTSA database.

Data collection

An interview tracking sheet was attached to each survey to provide a system for recording the steps in the data collection process. The progress chart recorded an identification number, state of origin, number of telephone calls made, outcome of each call and duration of interview.

The survey was administered between April and October 2002. The project staff made telephone calls to all agencies listed on the COTSA database and asked managers to participate in a telephone interview on a day and time that was convenient. Managers were offered the choice of completing a telephone interview or an electronic survey. One hundred and eight managers requested that the survey instrument be sent electronically.

A total of 234 surveys were completed by managers of treatment agencies. Several managers were responsible for more than one agency listed on the COTSA database and responded in terms of all agencies that they managed. A total of 318 agencies listed on the COTSA database were represented in the 234 interviews. Of the 234 managers that participated, 42 completed the electronic survey and the remaining 192 completed a telephone interview.

Contacting managers, arranging a time for a telephone interview and conducting the interview required 576 phone calls. An average of three phone calls was made for each completed telephone interview. Over 330 additional calls were made that did not result in an interview. In total 908 phone calls were made. Average interview length was 25 minutes (range 15-55 minutes). In addition to phone calls, 108 emails were sent, to provide information about the project and an electronic version of the survey instrument.

Limitations

The COTSA database was last updated for the 2001 census conducted by the National Drug and Alcohol Research Centre (NDARC). Since then a number of agencies have closed and many were uncontactable due to changes in contact details. A number of new agencies had

also opened in 2002 as a result of National Illicit Drug Strategy (NIDS) funding. These agencies could not be included in the current study.

In addition, there may be some self-selection bias in the sample as managers were invited to take part in this study. Managers who are strongly interested in the treatment and management of alcohol-related problems may be most likely to participate in this study.

There was considerable diversity in data collection systems and practices within the AOD treatment sector and across all states and territories. Some managers reported information based on client registration data while others based their responses on treatment episode data. Some agencies had the capacity to provide both types of data. It was noted that New South Wales, Victoria, and the Australian Capital Territory have systems in place that collect episodes of treatment care data rather than actual number of client registrations (AIHW 2002b). Data from these jurisdictions may underestimate the number of clients who have registered with an AOD inpatient or outpatient service over the last 12 months. The Australian Institute of Health and Welfare is working with agencies to maximise comparability of data by improving the consistency of agency record collection (AIHW 2002b).

During the telephone interviews managers frequently indicated that they did not have access to agency data and based their responses on estimates. Figures presented in this report for the percentage of clients who present with alcohol as their primary problematic drug and part of their polydrug use problem are in part based on agency data collection and in part on estimates. These data should therefore be interpreted with caution.

Non-response rate

All 549 agencies on the COTSA database were contacted by mail and telephone. The study had a minimum target of 50% of agencies in each state on the COTSA database.

Forty two percent (n=231) of the original sample did not participate in the research project, the reasons are listed in Table 5. Non-response categories 3-6 account for agencies that had closed, were uncontactable or not relevant to the study. These 63 agencies were removed from the sample leaving an adjusted denominator of 486 (549-63=486). The remaining 168 non-

Table 5: Non-respondents details (n=231)

Categories	Number	(%)
1. No response*	117	(51)
2. Manager too busy	48	(21)
3. Service not appropriate**	31	(13)
4. Phone disconnected	19	(8)
5. Agency rationalised/closed	8	(4)
6. Mail returned	5	(2)
7. Ethics approval required	3	(1)
Total	231	(100)

* No response to the two letters sent out and follow-up phone calls.

** No on-site AOD staff or alternate focus ie tobacco, illicit drugs/ methadone or education.

participating agencies were classified as valid non-respondents as they did not reply to the two letters or phone calls, stated they were too busy to participate or that it was necessary to seek additional ethics clearance from their agency.

These agencies represented a 35% non-response rate (168/486=35%) and a final response rate for the study of 65%.

Data analysis

Both quantitative and detailed qualitative data were collected in the survey of managers of specialist treatment agencies. The combination of quantitative and qualitative methods is regarded as a strength in this type of study. Quantitative methods are useful for generating summaries and comparisons while qualitative methods generate contextual information which allows for greater and deeper understanding (de Vaus, 1995).

Quantitative data were entered into the Statistical Package for Social Sciences (SPSS). These data were analysed using frequencies. Descriptive statistics were used to summarise the managers' responses. Key variables used in the analysis included the state, type of organisation, type of treatment service, adequacy of funding and personal demographics of managers.

The qualitative data are interspersed throughout the Results and Discussion sections of the report to maximise contextualisation and interpretability of these data.

Results

The results are presented in five sections:

- Subjects' participation details
- Managers' demographic details
- Alcohol and other drugs
- Characteristics of AOD agencies
- Workforce development.

Subjects' participation details

Two hundred and thirty four managers of AOD specialist treatment agencies completed the survey. Twenty seven managers responded on behalf of multiple agencies, accounting for data on 84 additional agencies and representing a total of 318 agencies. Overall, information was obtained from 65% (n=318) of the AOD specialist treatment agencies listed on the 2001 COTSA database.

The study met the minimum response target for each state of 50% of agencies on the 2001 COTSA database. Fifty nine percent (n=138) of respondents were managers of agencies located in metropolitan areas of Australia and 41% (n=96) were located in non-metropolitan areas. A breakdown of managers and additional agencies by state is shown in Table 6.

Table 6: Number of completed surveys and participating agencies by state/territory

State	Treatment agencies on 2001 COTSA database		Min 50% target	Completed surveys and additional agencies represented*		Total agencies represented N	State	Sample
	N	(%)						
SA	40	(7%)	20	19	(+12)	31	78	6
TAS	17	(3%)	9	9	(+2)	11	65	2
VIC	82	(15%)	41	35	(+13)	48	59	10
ACT	11	(2%)	6	7	(+2)	9	82	2
NSW	247	(46%)	124	88	(+52)	140	57	29
QLD	89	(16%)	45	44	(+1)	45	51	9
NT	23	(4%)	12	12	(+0)	12	52	2
WA	40	(7%)	20	20	(+2)	22	55	5
Total	549	(100%)	277	234	(+84)	318	–	65%**

* 27 Managers responded on behalf of several agencies ie they were responsible for more than one agency.

** The response rate has been adjusted for 63 agencies that were closed, non-contactable or inappropriate. The denominator for this calculation is 486.

Data provided by managers who represented multiple agencies have been aggregated. Except where specified, the number of managers interviewed (i.e. n=234) is used as the denominator, and not the number of agencies represented (n=318).

Managers' demographic details

The survey provided data on the gender and age of managers in the AOD field. It collected data on the length of time managers had spent in the AOD field and in their current managerial position. Data were collected on managers' professional background, managerial and AOD education, training and experience as well as how managers developed their AOD knowledge.

Managers' gender and age

Fifty seven percent (n=134) of respondents were female and 43% percent (n=100) were male as shown in Figure 5. Analysis of the number of male and female managers in government, non-government and private organisations revealed approximately similar proportions of female managers in government and non-government organisations (57%, n=56 and 55%, n=64, respectively). A high proportion of female managers was identified in private organisations (74% n=14).

Figure 5: Proportion of males and females in a sample of 234 AOD specialist treatment agency managers

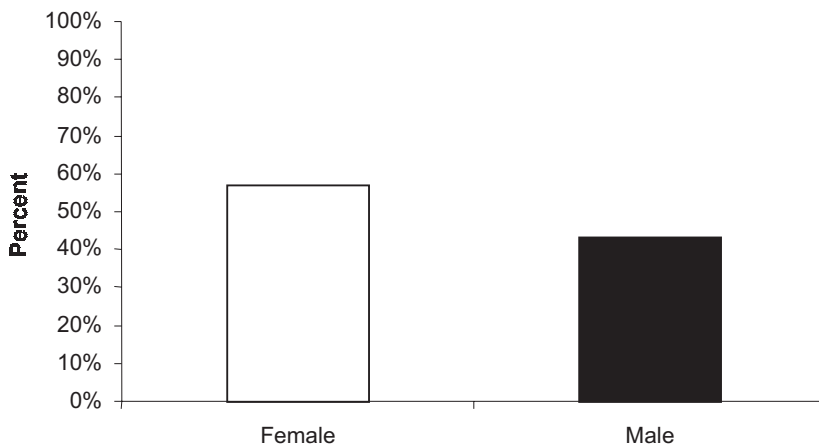

A gender analysis revealed similar proportions of male and female managers for metropolitan and non-metropolitan agencies. Among metropolitan agencies 43% (n=60) of managers were male and 57% (n=78) were female. In non-metropolitan agencies 42% (n=40) of managers were male and 58% (n=56) were female.

The mean age of managers was 46 years (range: 23-69 years, n=231). Very few managers were aged under 30 years. Nearly half of all managers were in the 41-50 year old age bracket, with a further 26% aged 51-60 years. Figure 6 shows the age and gender breakdown of the sample.

Figure 6: AOD specialist treatment agency managers by age and gender

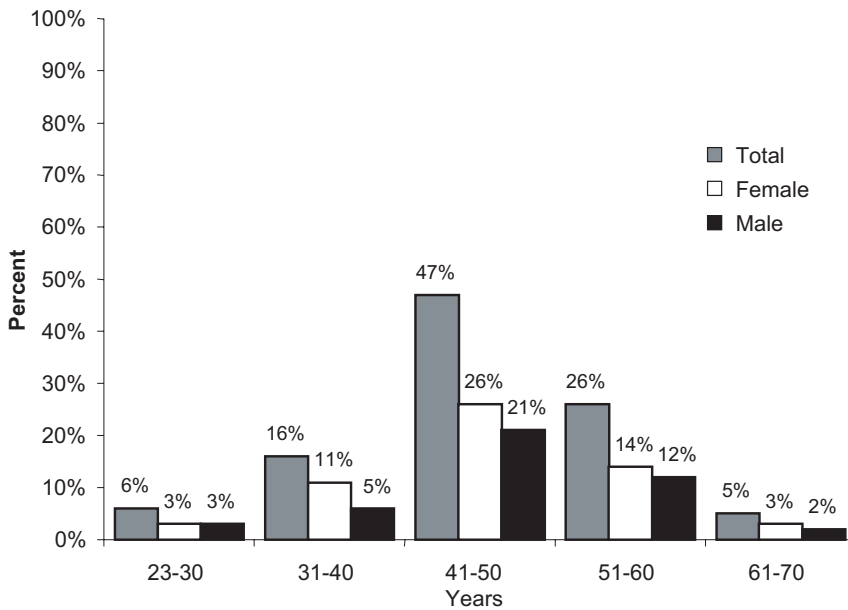

Time spent in the AOD field and current managerial position

The average time managers have worked in the alcohol and other drugs field is 12 years (range: 1-40 years, n=232). A quarter of the sample had been in the field less than five years as shown in Figure 7. Eight percent of managers (n=20) had spent less than two years in the field and 16% (n=37) had spent between three and five years in the field. Almost half of the sample (46%, n=104) had spent between 6-15 years in the field. The remaining 30% (n=71) had worked in the field between 16-40 years.

Figure 7: Length of time managers have spent in the AOD field

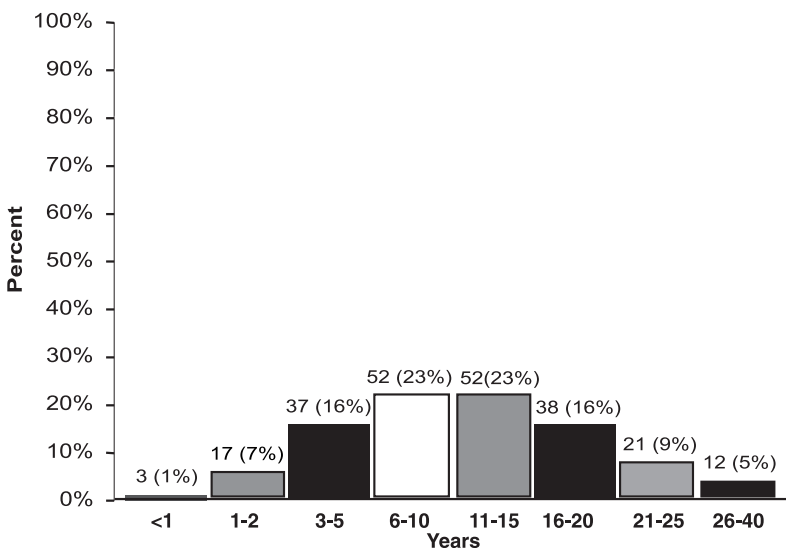

The average time managers had spent in their current managerial position was 4.8 years (range: 1-25, n=232). Figure 8 shows that nearly half the sample (45%, n=104) had been in their current managerial position for less than two years, while a quarter (26%, n=60) had been in their current position for between three to five years. Twelve percent (n=27) of managers had been in their current position for more than 10 years.

Figure 8: Length of time spent in current managerial position

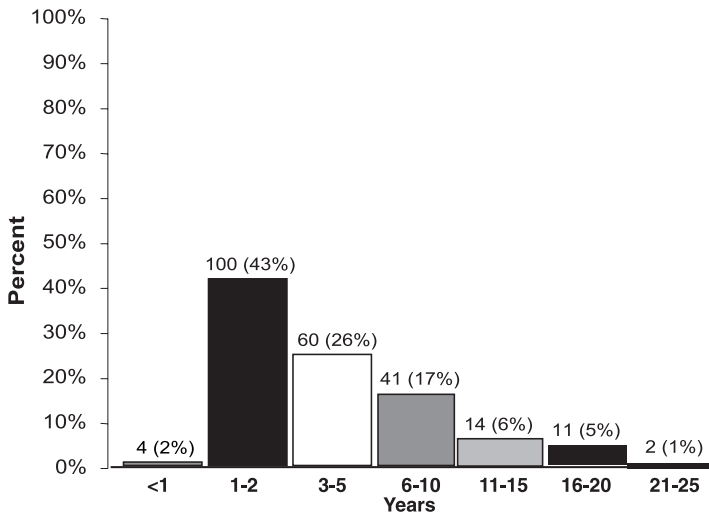

Managers were asked to describe their professional background. Four designated categories were specified as shown in Table 7. The majority of managers (67%, n=153) described themselves as health professionals, with a nursing, general practice or psychiatric background. Fifty five percent (n=125) were human service workers, e.g. psychologists, social workers and counsellors. Thirty seven percent (n=60) identified themselves as business people and over a quarter (26%, n=60) indicated they had relevant personal experience in the field. These categories were not mutually exclusive, and 120 respondents nominated more than one category.

Table 7: AOD specialist treatment agency managers' professional backgrounds

Professional groupings*	N	(%)
Health professional	153	(67)
Human services worker	125	(55)
Business person	84	(37)
Relevant personal experience in the field	60	(26)

* 120 managers selected more than 1 category.

Managerial and AOD education, training and/or experience

Managers were asked a closed question which required them to identify whether they had received any specific managerial education or training, or had any relevant experience. Managers who responded 'yes' were asked to describe their education, training and/or experience. Seventy nine per cent (n=184) of managers indicated they had managerial education, training or experience. Qualitative responses revealed approximately two thirds (n=113) of all

managers with managerial training and experience had received it in their previous or current workplace. Twenty nine percent (n=65) of managers reported they had gained tertiary qualifications in management and 20% (n=43) indicated they had attended short courses, workshops or seminars.

Ninety percent (n=210) of managers indicated they had some type of specific AOD education and/or training. They were then asked to describe the type of AOD qualification obtained against the set categories outlined in Table 8. The most common qualification reported by managers was non-accredited training courses (55%, n=129) followed by accredited short courses (36%, n=83). Approximately half the sample held a university qualification in AOD work or a related field (47%, n=108).

Table 8: AOD qualifications of specialist managers (n=233)

Type of qualification	N	(%)	Type of qualification	N	(%)
Non-accredited training course	129	(55)	Graduate Diploma	22	(9)
Accredited short course	83	(36)	Advanced Diploma/Postgraduate Degree (University)	12	(5)
Diploma/Undergraduate Degree (University)	55	(24)	Diploma in Community Services (AOD work) TAFE	5	(3)
Professionally endorsed qualification (police / nursing)	48	(21)	Advanced Diploma of Community Services (AOD work) TAFE	5	(3)
Masters (University)	39	(17)	Certificate III in Community Services (AOD work) TAFE	4	(2)
Graduate Certificate	25	(11)	Certificate II in Community Services (AOD work) TAFE	3	(1)
Certificate IV in Community Services (AOD work) TAFE	20	(9)	PhD / doctorate (University)	2	(0.8)

The qualification categories shown in Table 8 are not mutually exclusive and managers frequently nominated more than one category. Twenty seven percent (n=62) identified one category, 30% (n=70) identified two, 18% (n=43) identified three, 12% (n=27%) identified four, 4% (n=9) identified five and 1% (n=3) identified six different types of AOD education and training qualifications.

An open-ended question asked managers to describe how they had developed their knowledge about responding to AOD issues. The majority of managers (n=87) reported that this had been achieved through on-the-job training and life experience. Attending internal and external training sessions (n=77), reading (n=75), networking with colleagues and other agencies (n=69), attending conferences (n=46) and pursuing ongoing professional development (n=35) were the other major strategies used. Supervision (n=22), client contact (n=21), the internet (n=17), membership with professional bodies (n=13), research and program development (n=13) were also identified as strategies used to develop knowledge about responding to AOD issues.

Alcohol and other drugs

The survey obtained data on alcohol focused agencies, the nature of alcohol (as well as other drug) problems addressed by specialist treatment agencies, the proportion of clients who present with alcohol as the primary problematic drug, and clients who present with alcohol as a part of

problematic polydrug use. The survey also sought views on alcohol and polydrug use trends over the past 12 months and over the next three to five years, and managers' perceived ability to manage these trends effectively. The top five problematic drugs with which clients present were also identified.

Alcohol focused agencies

Fourteen percent (n=32) of managers reported that their agencies provided services which had an alcohol specific treatment focus, as shown in Figure 9. Ten percent (n=24) of managers reported their agencies had an illicit drug focus and 76% (n=178) managed agencies which had a combined focus on alcohol and other drugs.

Figure 9: The treatment focus of AOD specialist agencies

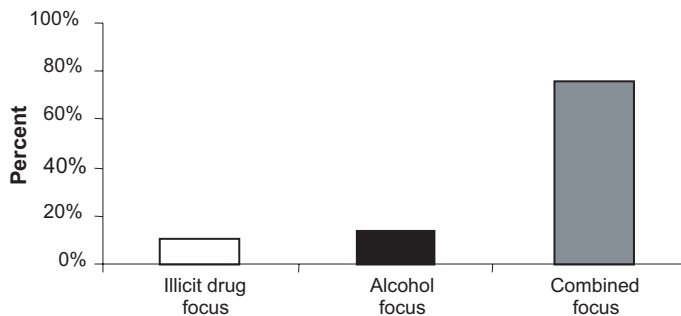

In the subset of managers of alcohol focused agencies three managers were collectively responsible for nine agencies, of these, two managers each managed two agencies and one managed eight, representing a total of 41 alcohol focused agencies. Data for each manager's multiple agencies were aggregated and treated as a single agency unit for the purpose of analysis. Unless otherwise specified, a denominator of 32 was used in the analysis, as this represents the number of managers of alcohol focused agencies.

Three quarters (76%) of the alcohol agencies were located in New South Wales, Queensland, Victoria and Western Australia. This study found that no agencies offered services exclusively for alcohol-related problems in Tasmania and the Australian Capital Territory. Table 9 indicates that agencies with an illicit drug and combined focus were present across all states.

Table 9: AOD specialist agencies' treatment focus by state/territory (n=234)

State	Alcohol	Illicit drugs	Combination	Total
SA	4	4	11	19
TAS	0	1	8	9
VIC	5	3	27	35
ACT	0	1	6	7
NSW	9	10	69	88
QLD	6	3	35	44
NT	3	1	8	12
WA	5	1	14	20
Total	32 (14%)	24 (10%)	178 (76%)	234

Agencies that provided treatment services primarily for clients with an alcohol-related problem were distributed equally between metropolitan (50%, n=16) and non-metropolitan areas (50%, n=16). Agencies with an alcohol focus represented 12% (n=16) of all metropolitan and 17% (n=16) of all non-metropolitan agencies.

Forty four percent (n=14) of alcohol focused agencies were government, 38% (n=12) non-government and 19% (n=6) private organisations (see Figure 10). Proportionally fewer alcohol agencies were provided by the non-government sector and more by the private sector. Of all agencies in the private sector, approximately a third (32%, n=6) were alcohol focused.

Figure 10: The proportion of government, non-government and private organisations among AOD specialist treatment agencies and the proportion that provide alcohol focused services

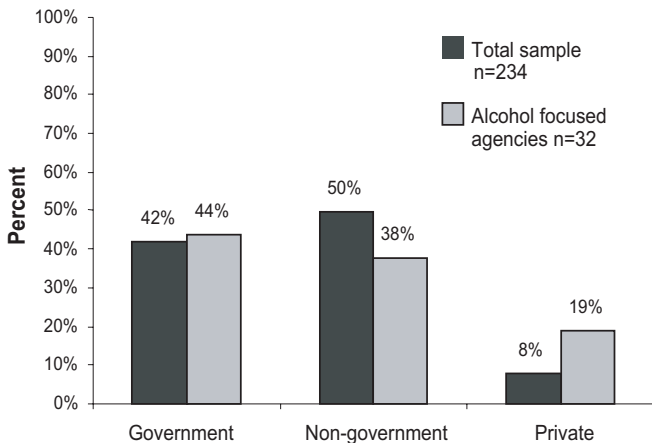

Two thirds of managers (66%, n=21) of alcohol agencies reported a harm minimisation approach, 28% (n=9) supported an exclusively abstinence orientation and 6% (n=2) provided an alternative approach. The alcohol agencies (66%, n=21) were less supportive of a harm minimisation treatment approach compared to the overall sample of AOD agencies (77%, n=181).

Agencies with an alcohol focus offered 32 inpatient and 25 outpatient services and 1 other (some agencies offered more than one service). Of the 58 treatment services offered, 13 were inpatient, 11 were outpatient and 33 were combined inpatient and outpatient services. The inpatient services included withdrawal, rehabilitation and/or therapeutic community programs. Outpatient services included withdrawal and/or rehabilitation. Outpatient (50%, n=16) and inpatient (47%, n=15) rehabilitation were the most frequently reported services. Over a third of managers (38%, n=12) reported inpatient withdrawal services and 28% (n=9) reported outpatient withdrawal services.

Managers reported their agencies offered a range of treatment options. Assessment, counselling, referral and education were offered by over three quarters of alcohol agencies. On site Alcoholics Anonymous (AA) meetings were reported by 44% (n=14) of managers and 34% (n=11) reported pharmacotherapy as a treatment option.

Fifty seven percent (n=16) of managers of alcohol focused agencies indicated that they provided treatment for a specific client group. Eighteen percent reported treatment services for Aboriginal and Torres Strait Islanders and in some instances their families. Other specific groups identified included adults, clients with private health insurance, clients with comorbid alcohol and mental health problems and navy personnel. Male or female exclusive services were also provided by some agencies. No alcohol specific services were reported for youth less than 18 years of age.

Almost 50% of managers (n=15) of alcohol agencies estimated that alcohol presentations had increased over the past 12 months compared to 35% (n=80) of managers in the overall survey. The majority of managers (72%, n=23) also predicted an increase in alcohol use trends over the next 3-5 years. This increasing trend was also found amongst managers (70%, n=163) in the overall sample. Over a third of the managers of alcohol focused agencies (39%, n=11) reported being unable to respond effectively to trends in alcohol use. Lack of resources, shortage of staff and /or inadequate funding were identified as the major reasons for difficulty in responding effectively.

Almost two thirds of managers of alcohol agencies (63%, n=20) reported difficulty in filling staff vacancies. Recruitment difficulties were reported to be due to a lack of qualified and experienced workers, poor remuneration, non-metropolitan location and/or stigma attached to working in the AOD sector.

Prevalence of alcohol-related problems

Managers (n=210) estimated that 45% of their clients would report alcohol to be their primary problematic drug. State differences shown in Figure 11 indicate that half or more of the client populations presenting to specialist agencies in the Northern Territory and Victoria identified alcohol as their primary problematic drug.

Figure 11: Managers' estimates of the percent of clients who report alcohol as their primary problematic drug



Managers estimated that 53% (n=168) of polydrug using clients also report alcohol-related problems. Over half of the polydrug using clients who presented for treatment in Tasmania, Western Australia, Victoria, Queensland, and the Northern Territory were estimated to have a problem with alcohol (Figure 12).

Managers were asked to rank in hierarchical order the drugs that clients describe as being most problematic for them. No prompts were given. Approximately two thirds of all managers (63%, n=142) ranked alcohol as their clients' most problematic drug¹. Cannabis was identified as the second most problematic drug, amphetamines as third, heroin fourth and benzodiazepines fifth. Figure 13 shows the top five ranked licit and illicit drugs.

A frequency count of the drug reported as the 'most' problematic (i.e. given rank order No. 1) revealed that, after alcohol, heroin was the next substance most often nominated as the No. 1

¹ Problematic drugs were defined as the drug with which clients present, not in the community at large.

problematic drug (Table 10). Support for heroin as the most problematic drug was indicated by only 11% of respondents.

Figure 12: Managers' estimates of the percent of polydrug using clients who report alcohol as part of their problem



Figure 13: Managers' perception of the five most problematic drugs of clients presenting to AOD specialist services (ranked from 1st to 5th position)
 [Note: different denominators used in each drug group]

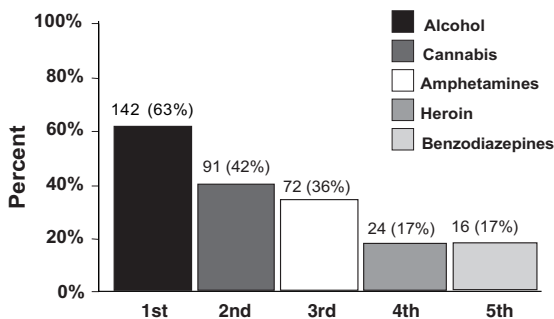

Table 10: Managers' perception of the most problematic drug reported by clients (n=227)

Substance	N	(%)
Alcohol	142	(63)
Heroin	29	(11)
Cannabis	22	(7)
Amphetamines	19	(6)
Opiates (other than heroin)	4	(1)
Tobacco	4	(1)
Methadone	2	(0.7)
Sustained release morphine	2	(0.7)
Benzodiazepines	1	(0.4)
Cocaine	1	(0.4)
Solvents/Inhalants	1	(0.4)

Trends in alcohol-related presentations

Managers were asked to estimate whether alcohol-related problems had increased, decreased, or remained static. They were then asked an open-ended question, ‘*what is the basis for your observation?*’ The majority of managers based their response on patterns and trends reflected in their agency’s own data collection and analyses. Figure 14 shows managers’ identification of trends for alcohol-related presentations over the past 12 months and their prediction of trends for the next three to five years.

Figure 14: Managers’ perception of past and future trends for alcohol presentations (n = 232 & 234 respectively)

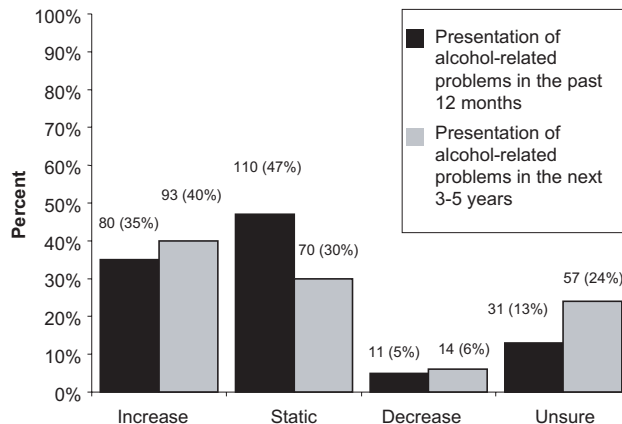

Over a third of respondents reported that alcohol-related presentations had increased over the past year, while approximately one half responded they had remained constant. Future increases in alcohol-related presentations were anticipated by 40% of managers while just under a third believed they would remain stable. Very few managers had seen decreases or expected decreases in alcohol-related presentations in the future.

Thirty five percent (n=80) of managers reported an increase in alcohol-related presentations over the past twelve months and 40% (n=93) predicted an increase in alcohol-related presentations over the next three to five years. When asked ‘*what is the basis for your observation/prediction*’ many managers attributed past and future increases in alcohol-related presentations to binge drinking and/or drinking in specific populations. Growing awareness of acute and chronic harms associated with high risk alcohol consumption, and increased treatment seeking behaviour were also reported to contribute to an increase in alcohol-related presentations. Social problems such as unemployment and homelessness and the affordability and accessibility of alcohol were also identified as influential factors. As one manager from Western Australia stated:

“There has been an increase in alcohol presentations as more young people are using alcohol to cope with their social and/or economic problems.” (WA:482.2.8)

Some managers identified an increase in alcohol use in conjunction with increasing amphetamine and polydrug use as additional reasons for their observation and/or prediction. The effect of the heroin drought was noted by some managers in Victoria and NSW as an explanation for the increase in alcohol presentations over the past 12 months.

Forty seven percent of managers (n=110) considered alcohol-related presentations had remained static over the past twelve months and 30% (n=70) considered it would remain so over the next

three to five years. Some managers expected binge drinking and drinking within specific populations would remain stable.

Five percent of managers (n=11) indicated they had observed a decrease in alcohol-related presentations during the past twelve months and 6% (n=14) thought alcohol related presentations would decrease over the next three to five years. Managers based their views on the estimated impact of education to increase knowledge and awareness of alcohol-related harms and reduce binge drinking and other unsafe patterns of alcohol consumption. A number of these respondents indicated that they believed drug use would increase while alcohol use would remain the same or decline.

Thirteen percent (n=31) of managers were unsure of the alcohol trends over the past twelve months and 24% (n=57) were unsure about trends over the next three to five years. These

Figure 15: Managers’ perception of past and future trends for polydrug use presentations (n = 232 & 233 respectively)

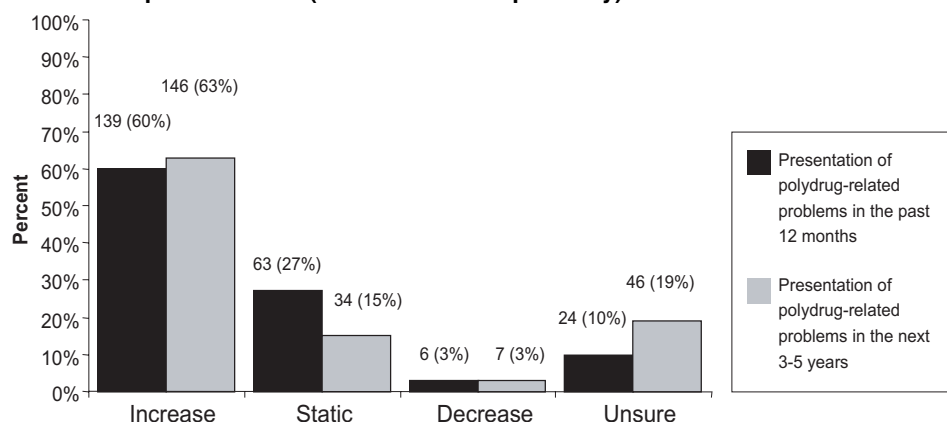

responses were most common where the agency did not have an alcohol focus, statistics were unavailable, the manager was new to the job or the agency was new.

Trends in polydrug-related presentations

Managers were asked to identify whether polydrug-related presentations had increased, decreased or remained static. The majority of managers’ responses were based on patterns and trends derived from their agency’s own data collection. Figure 15 shows managers’ identification of trends for polydrug-related presentations over the past 12 months and the next three to five years.

Overall, approximately two thirds of respondents reported increases in polydrug use over the past 12 months and a similar proportion expected this increased level of presentation to continue into the future. Approximately one quarter reported a static level of polydrug use in the past 12 months but only one in six expected this would continue. Very few managers reported decreases in polydrug use presentations.

Sixty percent (n=139) of managers reported an increase in polydrug presentations over the past twelve months and 63% (n=146) predicted an increase in polydrug-related presentations over the next three to five years. The majority of managers identified an increase in use of amphetamine type stimulants (including cocaine) as a major contributor to the increase in polydrug-related presentations. Other factors included the range of alcohol and other drugs

available, their accessibility and affordability and the impact of the heroin drought. Managers also commented on increases in the use of prescription opioids/benzodiazepines and the increasing complexity of polydrug use, including secondary problems (e.g. infections) and multiple disorders requiring specialist treatment (e.g. mental health dual diagnosis issues). Only those reporting an increase over the past twelve months noted increasing cannabis use.

Twenty seven percent (n=63) of managers indicated presentations relating to polydrug use had been static over the past twelve months and 15% (n=34) considered this would continue over the next three to five years. Little mention was made of reasons why polydrug-related presentations had remained static.

The 3% (n=6) of managers who reported a decrease over the last 12 months, as well as those (3%, n=7) who predicted a decrease over the next three to five years, based their observations and predictions on trends in data collected by their agency.

Ten percent (n=24) of managers were unsure of trends in polydrug presentations over the past twelve months and 19% (n=46) were unsure of the trends for the next three to five years. Managers were unsure of past and present trends where agencies did not have a polydrug focus, statistics were unavailable, it was a new agency, or the manager was new to the job.

Ability to manage and respond to trends effectively

Approximately half (51%, n=112) the sample indicated that they believed they could effectively manage and respond to trends in alcohol presentations, as shown in Figure 16. Almost a quarter of respondents felt they could not offer effective responses and another quarter were unsure.

Figure 16: Managers' ability to respond effectively to future alcohol and polydrug trends

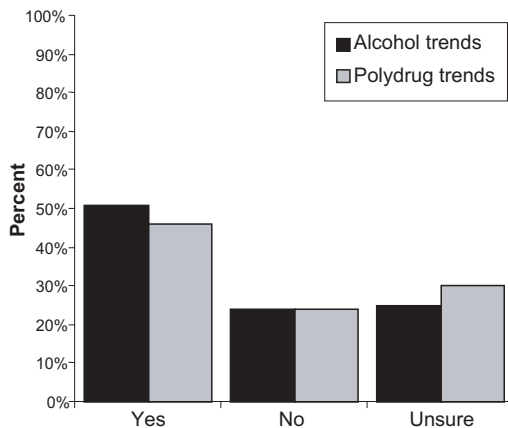

Confidence in the ability to effectively manage and respond to alcohol trends is reflected in the following statement by a Western Australian manager:

“Alcohol patients are the easiest to manage clinically. Staff have a lot of experience, treatment approaches are much the same – counselling and rehabilitation. Staff are also trained in pharmacotherapy. We are not anticipating any major change in the treatment approach for alcohol-related problems.” (WA:497.2.13)

Forty six percent (n=100) of managers believed they could effectively manage and respond to polydrug trends. When asked an open-ended question that sought clarification some managers

reported that they were well resourced, offered a range of services and had a flexible service approach.

Others indicated that they had managed current alcohol and polydrug trends with their existing resources and expected they would continue to do so. However, respondents acknowledged that having skilled and/or trained staff was a large component of being able to manage and respond to these trends.

Twenty four percent of the sample thought they would not be able to manage and respond to present and future alcohol (n=52) and polydrug trends (n=53). This was largely attributed to lack of resources, staffing and funding. In particular, lack of facilities, closure of beds and programs, inability to retain staff, lack of qualified staff, and unique challenges in rural areas were highlighted.

Managers who indicated they would have difficulty managing polydrug trends frequently identified mental health issues and dual diagnosis as a reason for this. As a manager from Western Australia stated:

“We are not doing fantastically well with amphetamine users, the reality is a lot of amphetamine users end up in the mental health system. They are very difficult to manage in traditional AOD services.” (WA:497.2.19)

Twenty five percent (n=55) of managers were unsure if their agency could manage alcohol trends and thirty percent (n=66) were unsure of their agency’s capacity to manage and respond to future polydrug trends. Funding limitations and service delivery issues such as workload, staffing and the possibility of waiting lists were given as reasons for managers’ uncertainty.

The complexity of polydrug use and limitations in service provision were additional factors identified by managers who predicted difficulty in responding effectively to polydrug trends.

Characteristics of AOD agencies

Types of organisations

Forty two percent (n=98) of managers were from government agencies, 50% (n=117) were from non-government and 8% (n=19) from private agencies as shown in Figure 17. The state distribution of organisations by type is available in Appendix B (see Table 26).

Figure 17: Proportion of managers from government, non-government and private agencies (n=234 managers)

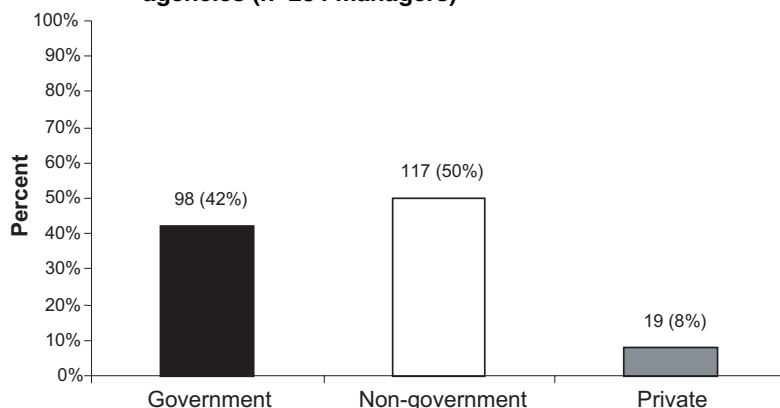

Overall, 59% of agencies were located in metropolitan areas. Over 50% of government, non-government and private agencies were located in a metropolitan area see Table 11. More than four out of five private agencies were located in a metropolitan area.

Table 11: Distribution of AOD treatment organisations by metropolitan and non-metropolitan location (n=234)

Organisation Type	Metropolitan		Non-metropolitan	
	N	(%)	N	(%)
Government	52	(53)	46	(47)
Non-government	70	(60)	47	(40)
Private	16	(84)	3	(16)
Total	138	(59)	96	(41)

Services offered by AOD agencies

Agencies offered a range of services to meet client needs. These services were broadly classified into four categories: inpatient, outpatient, rehabilitation and withdrawal (or detoxification). Treatment services such as assessment, counselling, education and referral were offered within both rehabilitation and withdrawal programs.

The total number of inpatient and outpatient services offered was 398. Two hundred and twenty seven agencies offered outpatient rehabilitation and/or withdrawal services and 164 agencies offered inpatient or residential services including inpatient rehabilitation and/or withdrawal and therapeutic communities. Seven services were identified as 'other'.

Table 12 indicates that 64% (n=149) of the sample provided outpatient rehabilitation services. Outpatient withdrawal was provided by 33% (n=78) of the sample. Both types of services were provided either on-site or within the home setting.

Table 12: Types of services provided by AOD specialist treatment agencies in Australia

Type of Service	N	(%)
Outpatient rehabilitation	149	(64)
Outpatient withdrawal	78	(33)
Inpatient withdrawal	65	(28)
Inpatient rehabilitation	64	(27)
Therapeutic community	35	(15)
Other	7	(3)

* N=234. Managers could nominate more than one type of service.

Twenty seven percent (n=64) of the sample offered inpatient rehabilitation and 28% (n=65) offered inpatient withdrawal. These services were offered either in a short term or long stay residential setting.

Therapeutic communities were identified separately, and comprised 15% (n=35) of the sample.

Half of the total sample, 51% (n=119), offered only one type of treatment service, 32% (n=75) offered two, 14% (n=33) offered three, 2% (n=5) offered four and 1% (n=2) offered five types of treatment services. Details of the number of inpatient/outpatient rehabilitation/withdrawal services offered within each state/territory are available in Appendix B (see Table 27).

Sixty percent (n=98) of inpatient services had a waiting list. Waiting periods ranged from 1-90 days (median² and mode³=14). The average (mean) number of clients on waiting lists was 12 (range 1-54).

Managers were asked to identify from a list of 16 options the alcohol and other drug treatment services offered by their agency. Managers were given the option of specifying additional services in the 'other' category. Table 13 shows the range of services provided and shows a breakdown of 'other' services offered. Counselling (95%, n=222), referral (93%, n=217), assessment (88%, n=206) and education (85%, n=198) were offered by over three quarters of the sample. Community education, family counselling, outreach work and diversion programs were the four most frequent activities in the 'other' category. Dual diagnosis services were also identified in this category and were provided by 6% (n=14) of agencies.

Table 13: Treatment services provided in 2002 by AOD specialist treatment agencies (n=234)

Major services provided	N	(%)	'Other' additional services	N	(%)
Counselling	222	(95)	Community education	43	(18)
Referral	217	(93)	Family counselling and support	37	(16)
Assessment	206	(88)	Outreach	29	(12)
Education	198	(85)	Diversion programs	24	(10)
Group work/counselling	162	(69)	Dual diagnosis	14	(6)
Follow up service	157	(67)	Hospital GP liaison	14	(6)
Crisis management	148	(63)	Needle syringe programs	13	(6)
Rehabilitation	145	(62)	Home detoxification	12	(5)
Withdrawal management	134	(57)	Prison work	11	(5)
Medication management	118	(50)	Alcoholics Anonymous off site	11	(5)
Self help program	109	(47)	Case management	9	(4)
Accommodation	108	(46)	Narcotics Anonymous	8	(3)
Other pharmacotherapies	85	(36)	Natural/alternate therapies	6	(3)
Methadone maintenance	74	(31)	Recreational activities	8	(3)
Alcoholics Anonymous	69	(29)	Sobering up unit	6	(3)
Work program	58	(25)	Training AOD workers	7	(3)
			Gambling counselling	3	(1)
			Mobile overdose response team	3	(1)

Client groups served

Managers were asked whether their agency provided services for a specific client group. Almost half of the sample (52%, n=116) provided services for the general population. The most frequently identified specific client groups were adults only (14%, n=30) and youth⁴ only (9%, n=19). Other major client groups included exclusively male services and services for Australian and Torres Strait Islanders (ATSI) and their families. Managers' responses were

2 The median is the value above and below which half the cases fall, the 50th percentile. The median is a measure of central tendency not sensitive to outlying values - unlike the mean, which can be affected by a few extremely high or low values (De Vaus, 1995).

3 The mode is the most frequently occurring value. If several values share the greatest frequency of occurrence, each of them is a mode (De Vaus, 1995).

4 For the purpose of this study youth were defined as individuals aged between 12-25.

Table 14: Managers' identification of the principal client group catered for by their agency (n=234)

Specific group	N	(%)	Specific group	N	(%)
No specific group	116	(52)	Dual diagnosis	4	(2)
Adults (18 years and over)	30	(14)	Private health insurance	4	(2)
Youth (12-25 years)	19	(9)	Clients with dependents	3	(1)
Males only	12	(5)	Construction workers	2	(1)
ATSI	9	(4)	Homeless	2	(1)
Females only	7	(3)	Alcohol only	1	(0.5)
Justice system	7	(3)	Navy personnel	1	(0.5)
Illicit drug users	5	(2)	Total*	222	(100)

* Denotes 12 non-response missing cases.

coded according to the major defining characteristic of their client group. Table 14 lists the specific client groups for whom services were identified.

Managers identified youth, family members, clients with a co-occurring mental illness and clients in a rural or remote areas as needing additional attention.

Youth

Managers identified the need for more youth focussed services to cater for the treatment needs of people aged as young as 10 years. Alcohol was seen as a major problem for young people and the capacity of agencies to help clients under 18 was questioned. As one manager from NSW highlighted:

“There are no services available in our area for people under the age of 16, especially for alcohol.” (NSW:43.2.13)

Families of clients

Some agencies identified a need to provide support and/or therapy for the families of clients with an alcohol or other drug problem. As two managers from Tasmania and the Northern Territory stated:

“We need to involve family members, it is very important as they are an integral source of support for the user.” (TAS:516.4.12)

“We need to work with the family unit to lower alcohol consumption and violence.” (NT:528.4.12)

Comorbidity

Clients with a co-occurring mental illness and AOD related problems were also identified as having special treatment needs that were frequently not met by AOD specialist treatment agencies. Increasing presentations of clients with psychosis and/or aggressive behaviour patterns places additional pressure on agencies. As a manager from Tasmania indicated:

“We need to respond better to people with dual needs.” (TAS:511.4.12)

Rural and remote clients

Clients in rural and remote areas were also reported to have unique needs. As one rural manager highlighted:

“Alcohol is a cultural norm, urban and non-urban population attitudes are different, binge drinking/short sharp consumption is supported by society especially for industry and rural workers.” (NT:530.4.12)

Some managers reported that clients’ treatment needs are often constrained by physical access difficulties, fear of knowledge of their problem ‘getting out’ in a small community, and/or infrequent outreach worker visits due to the large geographic areas serviced. Additionally, rural and remote residents may be required to travel to the nearest regional centre for inpatient services, which has implications for access to after care and follow up.

Treatment approach

Over three quarters of the sample (77%, n=181) identified their agency’s approach as harm minimisation as shown in Table 15. Ninety percent (n=88) of government, 71% of non-government and 53% of private agencies advocated harm minimisation.

Table 15: Type of treatment approach used in the AOD government, non-government, and private sectors

Agency treatment approach	Government		NGO		Private		Total	
	N	(%)	N	(%)	N	(%)	N	(%)
Harm minimisation*	88	(90)	83	(71)	10	(53)	181	(77)
Exclusively abstinence	6	(6)	23	(20)	6	(32)	35	(15)
Other approaches**	3	(3)	10	(8)	1	(5)	14	(6)
Missing (non response)	1	(1)	1	(1)	2	(10)	4	(2)
Total	98	(42)	117	(50)	19	(8)	234	(100)

* Managers identified a continuum of harm minimisation that could include abstinence.

** Other approaches identified: a client directed approach and abstinence that can include harm minimisation.

Only 15% (n=35) of the sample reported an exclusively abstinence based approach. These managers were predominantly located in non-government and private organisations.

Two alternative treatment approaches were identified. The first was a client directed approach, providing clients with a choice of how they would like to be supported in managing their problem. The second alternate approach was abstinence that can include harm minimisation. A strong distinction was made between this response and harm minimisation that can include abstinence by the five non-government based respondents who nominated this option.

Funding levels

Seventy two percent (n=166) of managers reported funding to be inadequate for the effective operation of their agencies (Figure 18). A table depicting assessments of funding levels by state/territory is available in Appendix B (see Table 28).

When responses were examined according to type of organisation, as shown in Table 16, a higher proportion of managers from non-government organisations (84%) identified their funding as inadequate compared to government (63%) and private (39%) organisations. The majority of managers (61%, n=11) from private organisations indicated their funding was adequate as a result of private health insurance and the “user pays” system.

The reported inadequacy of funding was more pronounced for agencies in non-metropolitan areas. Seventy eight percent (n=75) of managers from non-metropolitan areas indicated their funding was inadequate compared to 67% (n=91) in metropolitan areas.

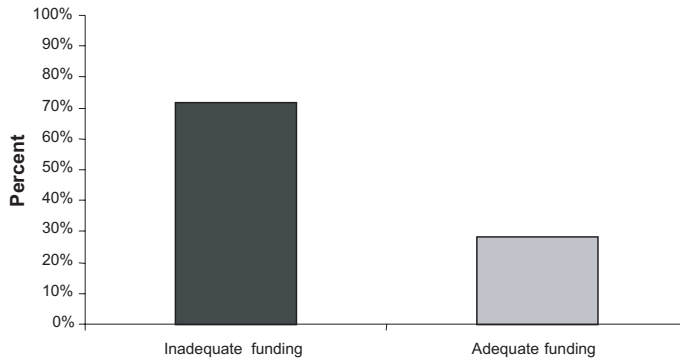
Figure 18: Managers' perception of the adequacy of their funding (n=232)

Funding pressures for non-metropolitan agencies are highlighted in the following statement by a Victorian manager:

“...funding does not allow for vehicles which are a necessity in the delivery of services in a rural location.” (VIC:279.1.10.1)

In non-metropolitan areas 70% (n=32) of government, 90% (n=42) of non-government and 33% (n=1) of private organisations reported inadequate funding. Among agencies in metropolitan areas 57% (n=29) of government, 80% (n=56) of non-government, and 40% (n=6) of private organisations reported inadequate funding.

Managers who identified their funding as inadequate were asked to describe the way lack of funding impacts on their agency. Managers (n=100) reported that inadequate funding impacted on the level of current and future service provision especially in the area of prevention and intervention, mental health and outpatient services.

Managers also indicated that inadequate funding resulted in staffing issues. Eighty seven managers reported that budgetary constraints affected their ability to fund appropriate staffing levels, resulting in high client/staff ratios and heavy staff workload. Concern was also expressed about the ability to cover salary increases and fund staff training and support.

Managers described a lack of general (unspecified) resources as a result of low levels of funding. Forty six managers commented on their inability to provide and maintain infrastructure. Thirteen managers specified that low levels of funding lead to difficulty in recruiting and retaining staff.

Staff vacancies

Sixty four percent of managers reported difficulties filling staff vacancies, as shown in Figure 19. Lack of qualified and/or experienced workers (n=67) and poor remuneration (n=39) were the two most frequently reported reasons for difficulty in filling vacancies. Other factors

Table 16: Managers' perception of adequacy of funding by type of organisation

	Adequate		Inadequate	
	N	(%)	N	(%)
Government (n=97)*	36	(37)	61	(63)
Non-government (n=117)	9	(16)	98	(84)
Private (n=18)*	11	(61)	7	(39)
Total	66	(28%)	166	(72%)

* Denotes one missing case.

Figure 19: Managers’ perception of difficulty in filling staff vacancies (n=231)

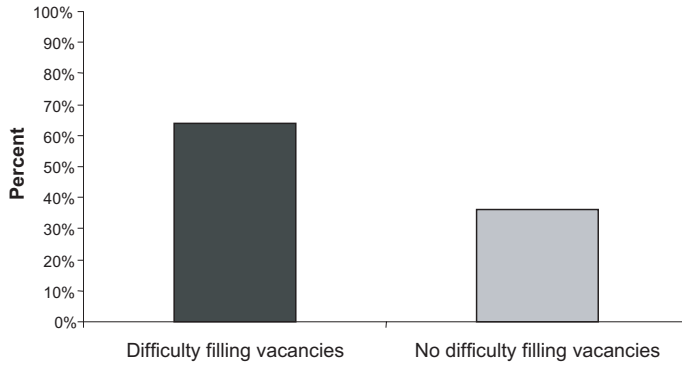

included the challenges of working in a rural location (n=27), the stigma attached to the field (n=26), and the shortage of nurses (n=24).

Managers also identified recruitment/retention and career opportunity issues (including lack of incentives, less incentive to work part time, short term contracts, no security, shift work and high workload) as detrimental to their ability to recruit staff and fill vacancies.

Managers in WA and NSW commented on the difficulty recruiting and retaining staff:

“We have limited wages available. Trained staff expect higher wages, so we have to get staff without specific AOD experience and train them. Then, the staff with training often move to better paid positions.” (WA:486.3.6.1)

“Until the AOD field becomes recognised as a preferred career opportunity for school leavers with relevant university qualifications, there will be difficulties recruiting professional staff. Also, as a consequence of no formal training requirements, employees are required to be skilled on the job, which is a costly exercise for programs, and difficult for clients.” (NSW:923.6.1)

Thirty six percent of managers did not experience difficulty filling vacancies. This was partly attributed to lack of vacancies due to a stable workforce. A number of managers also indicated that their agency had good networks/links in the field, they had appropriate applicants apply and people wanted to work at these agencies. In several instances, this was reported to be further enhanced by recruiting and training locally.

Difficulty in filling staff vacancies was equally distributed across the different types of agencies. Table 17 shows the majority of government (68%, n=67), non-government (60%, n=68) and

Table 17: Managers’ perceptions of the difficulty filling vacancies by type of organisation (n=231)

	Difficulty		No Difficulty	
	N	(%)	N	(%)
Government (n=98)	67	(68)	31	(32)
Non-government (n=114) *	68	(60)	46	(40)
Private (n=19)	12	(63)	7	(37)
Total	147	(64)	84	(36)

* Denotes three missing cases.

private agencies (63%, n=12) had difficulty filling vacancies. A further breakdown of managers' responses by state is available in Appendix B (see Table 29).

Sixty two percent (n=85) of managers in metropolitan areas and 66% (n=62) of managers in non-metropolitan areas indicated difficulty filling staff vacancies.

Analysis of metropolitan data by type of agency revealed that 60% (n=31) of government, 64% (n=44) of non-government and 62% (n=10) of private organisations reported difficulty filling vacancies. In non-metropolitan areas 78% (n=36) of government, 53% (n=24) of non-government and 66% (n=2) of private organisations had difficulty filling vacancies.

Managers were asked to rank in hierarchical order the three qualities they looked for when employing staff. A range of characteristics were identified, as shown in Table 18. The qualities most frequently identified were:

1. personal qualities e.g. empathy, sensitivity and being non judgemental
2. AOD skills and experience
3. AOD qualifications.

Table 18: Top eight qualities perceived by managers as important when employing AOD staff

	Frequency of responses			Total Mentions
	Rank 1	Rank 2	Rank 3	
1. Personal qualities (empathic, sensitive, non-judgmental, open-minded)	65	63	76	204
2. AOD skills and experience	59	59	29	147
3. AOD qualifications (education/training)	40	23	23	86
4. Organisational compatibility	16	28	32	76
5. Other professional experience/qualifications	15	15	5	35
6. Understanding/support of harm reduction	4	2	3	9
7. Indigenous status/culturally appropriate	3	2	2	7
8. Other*	10	10	13	33
Total	212	202	183	597

* Qualities mentioned in the 'other' category included such requirements as being drug free, being Christian and having a security clearance.

Identifying the AOD workforce

One objective of the survey was to obtain a detailed picture of the workforce. Managers from 318 agencies (65% of all agencies listed on the COTSA database) reported that their services involved a total workforce of 6,668 as shown in Table 19. Seventy percent of the workforce (n=4690) were identified as therapeutic staff. Twenty seven percent (n=1811) of staff are non-therapeutic workers eg ancillary staff, project officers and managers without a case load. Administration staff were also included in this figure. These figures are shown in Table 19 and Figure 20.

The total estimated staff numbers have been extrapolated from the 65% sample, with the relative distribution of the staff categories held constant for the full 100% sample.

Table 19: Summary table of staff working in 318 specialist treatment agencies and an estimate of staff numbers for the 486 valid agencies listed on the 2001 COTSA database

Type of staff	N	(%)	Total estimated staff
Therapeutic staff	4,690	(70)	7,167
Other staff	1,811	(27)	2,768
Alcohol specific staff	167	(3)	255
All staff	6,668	(100)	10,190

Figure 20: AOD workforce reported for 318 AOD specialist agencies (65% of agencies on the COTSA database) and estimated workforce for 486 valid agencies listed on the 2001 COTSA database

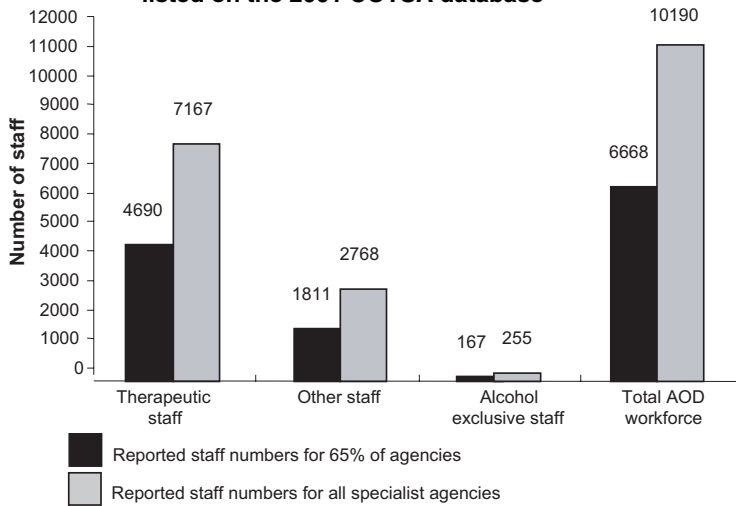

Managers were asked whether any of their staff worked exclusively with clients with alcohol-related problems. The most frequent response was “No” (92%, n=214). Managers maintained a multi-skilled workforce that could engage with any client with an alcohol or other drug problem. Of the managers who did identify alcohol specific workers (8%, n=19), these positions were often identified as drink drive instructors or community educators.

Managers were asked to define their workforce by occupational group. Table 20 indicates that the majority of workers are nurses (26%, n=1206), followed by general AOD workers (19%, n=873) and psychologists (9%, n=400). Counsellors (n=272), social workers (n=265) and administration staff (n=234) each represent approximately 5-6% of the specialist workforce.

Tables 19 and 20 and Figure 20 also display the total estimated number of staff working in specialist treatment agencies. Figure 21 shows the top nine occupational groups.

Staff development and training

Managers were asked to identify staff development and training initiatives within their agencies against a set list of eight categories, including an ‘other’ category (as shown in Table 21). Multiple responses could be given. The most frequently cited initiatives were in-house training programs (84%, n=195), supervision (82%, n=191), conference leave (78%, n=181) and study leave (76%, n=178).

Table 20: Reported (and estimated) number of therapeutic staff working in 318 (and 486) AOD specialist treatment agencies

Occupation	Actual staff		Estimated staff* N	Occupation	Actual staff		Estimated staff* N
	N	(%)			N	N	
Nurses	1,206	(26)	1,843	Allied Health	70	(1)	107
AOD workers	873	(19)	1,334	Psychiatrists	60	(1)	92
Psychologists	400	(9)	611	Ancillary staff	60	(1)	92
Counsellors	272	(6)	415	Teachers/Trainers	58	(1)	89
Social workers	265	(6)	405	Managers	49	(1)	75
Administration	234	(5)	358	Health/Edu officers	33	(0.7)	50
Youth workers	209	(4)	319	Graduates***	26	(0.5)	40
Doctors	175	(4)	267	Aboriginal workers	17	(0.4)	26
Peer workers**	154	(3)	235	Project officers	9	(0.2)	14
Volunteers	94	(2)	144	Pharmacists	7	(0.1)	11
				Other staff	419	(9)	640
				Total****	4,690	(100)	7167

* Managers who answered for multiple agencies provided an aggregate staff total and breakdown. The 65% response rate was used to calculate an estimate of the total number of AOD workers in the sector, by occupation.

** Peer workers were defined as workers who are similar to the client group in terms of characteristics such as age, gender or cultural background, have had similar life experiences and have sufficient social standing or status within the group to exert influence.

*** Graduates were defined as employees with an undergraduate degree in the area of social science.

**** Managers provided estimates of the number of people their agency employed (not full-time equivalents).

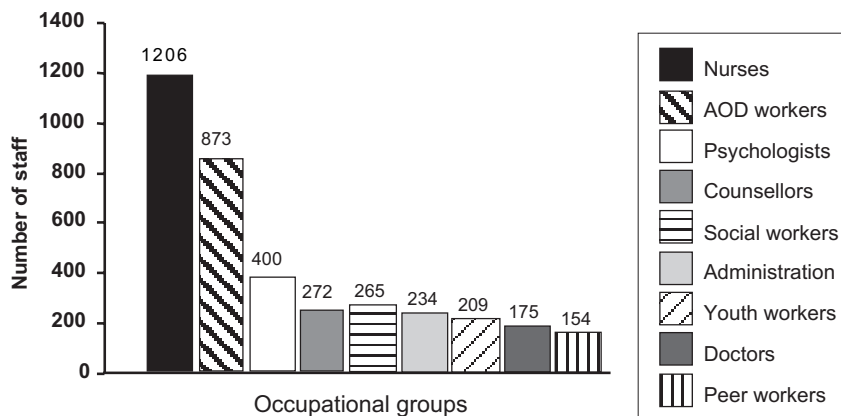
Figure 21: The top nine occupational groups working in the AOD treatment sector

Conference leave and study leave were more likely to be provided by government organisations while in-house training was more frequently provided by non-government and private agencies.

Managers indicated a high level of uptake of staff development and training opportunities with 74% (n=165) of staff always or frequently taking advantage of these options, as shown in Table 22. Non-government and private organisations reported that about a third of their staff 'always' utilise staff development opportunities compared to only 16% (n=15) of government organisations.

Table 21: Managers’ description of their agency’s staff development and training initiatives (n=233)

Systems	Government N=98		NGO N=116		Private N=19		Total N=233	
	N	(%)	N	(%)	N	(%)	N	(%)
In-house training programs	81	(82)	97	(84)	17	(90)	195	(84)
Supervision	76	(78)	101	(87)	14	(74)	191	(82)
Conference leave	79	(81)	87	(75)	15	(79)	181	(78)
Study leave	81	(82)	86	(74)	11	(58)	178	(76)
Financial assistance for study	52	(53)	53	(46)	12	(63)	117	(50)
Mentoring	44	(45)	63	(54)	9	(47)	116	(50)
No formal systems	16	(16)	22	(19)	2	(11)	40	(17)
Other:								
External training programs	13	(13)	11	(10)	0	(0)	24	(10)
Appraisals	7	(7)	6	(5)	2	(11)	15	(6)
Peer support	6	(6)	6	(5)	3	(16)	15	(6)
Placement providers*	1	(1)	4	(3)	0	(0)	5	(2)

* Provide student and staff placements and/or secondments.

Table 22: Frequency of uptake of staff development and training initiatives (n=223)

Response	Government		NGO		Private		Total	
	N	(%)	N	(%)	N	(%)	N	(%)
Always	15	(16)	36	(33)	6	(32)	57	(26)
Frequently	56	(60)	47	(42)	5	(26)	108	(48)
Occasionally	18	(19)	22	(20)	7	(37)	47	(21)
Rarely	2	(2)	4	(4)	0	(0)	6	(3)
Never	3	(3)	1	(1)	1	(5)	5	(2)
Total	94	(100)	110	(100)	19	(100)	223	(100)

Table 23: Managers’ response to the question ‘do the staff development programs supported by your agency adequately prepare people to respond to AOD problems?’ (n=220)

Response	Government		NGO		Private		Total	
	N	(%)	N	(%)	N	(%)	N	(%)
Yes	58	(40)	75	(51)	13	(9)	146	(66)
No	21	(43)	24	(49)	4	(8)	49	(22)
Unsure	14	(56)	9	(36)	2	(8)	25	(11)

Managers were asked if they thought the staff development and training programs they supported adequately prepared their workers to respond to AOD issues. Table 23 indicates the majority of managers (66%, n=146) reported that the staff development programs supported by their agency adequately prepared workers to respond to AOD issues. When asked to expand on this some managers (n=38) provided examples of effective staff development strategies including clinical supervision, mentoring, a buddy system and in-house training.

Some managers qualified their responses regarding the effectiveness of staff development by commenting on the various ways that training is constrained by funding and access issues such

as distance from training centres and time available for training. A number of comments were also made regarding the need to support staff to be able to access and complete training and the difficulty in evaluating the effectiveness of training.

Twenty two percent (n=49) of managers reported that they believed staff development programs did not adequately prepare staff to respond to AOD issues. Managers' explanations included lack of ongoing training, time pressures on staff and lack of appropriate training for already highly skilled staff.

Eleven percent (n=25) of managers were unsure of the adequacy of staff development programs.

Workforce development

Defining workforce development

In an open-ended question managers were asked to define the term workforce development. Answers were allocated to one of five main response categories. These are displayed in Table 24, ranked according to total number of times the theme was mentioned. Categories are not mutually exclusive.

The most common interpretation of the term workforce development was the traditional concept of staff development. This accounted for 44% of all responses. The next most common understandings of workforce development were those focusing on the functional aspects of workforce development i.e. recruitment and retention issues (indicated by 22%), and an organisation and systems perspective (supported by 17%) of respondents. Only 5% of the sample were unsure of what the term workforce development meant or felt it irrelevant.

Table 24: A typology of managers' understanding of workforce development

Category	Description	N
1. Traditional staff development	The most frequent comments about workforce development were in terms that can be defined as traditional concepts such as staff development, professional development, provision of and/or access to education and training.	137
2. A functional workforce development perspective: recruiting, developing and maintaining a pro-active skilled workforce	Workforce development was also defined as recruiting, selecting, inducting and maintaining skilled staff to meet changing needs and provide a quality service. Identifying learning and training needs, providing ongoing support and the opportunity to access study and training were emphasised.	68
3. A systems and organisational perspective of workforce development	Workforce development was defined by some managers as developing/improving the sector through organisational development, capacity building, building competencies, quality assurance, best practice, program review, policy development, research, increasing the sustainability of the workforce and providing appropriate pay.	54
4. Individual workforce development	Workforce development was defined according to the following kinds of staff support and empowerment issues: orientation, clinical supervision, debriefing, teamwork, team meetings, team building, performance review/appraisals, evaluation and staff support.	38
5. Unsure/irrelevant	The meaning of workforce development was unclear and managers were unable to define it. Some managers had never heard of it, while some thought it irrelevant.	14

Workforce development issues

Managers were asked to identify workforce development issues relevant to their agency. Respondents were invited to comment on a checklist of nine potential workforce development issues and needs for the field, as shown in Table 25. Additional comments were also recorded.

Table 25: Managers' identification of workforce development issues within specialist treatment agencies, by type of organisation and rank ordered by frequency of response

Workforce development needs	Government N=98		NGO N=117		Private N=19		Total N=234	
	N	(%)	N	(%)	N	(%)	N	(%)
1. Education and training	79	(81)	101	(86)	17	(90)	197	(84)
2. More funding	68	(69)	102	(87)	10	(53)	180	(77)
3. Staff to backfill positions	66	(67)	84	(72)	7	(37)	157	(67)
4. Need for professionalisation of AOD workers	52	(53)	76	(65)	12	(63)	140	(60)
5. More management support	52	(53)	75	(64)	9	(48)	136	(58)
6. Other e.g. rural issues, funding, staffing, comorbidity	61	(62)	62	(53)	11	(58)	134	(57)
7. Implementation of workforce development policies	46	(47)	63	(54)	9	(48)	118	(50)
8. Lack of suitable courses / training	47	(48)	51	(44)	8	(42)	106	(45)
9. Provide incentives to attend training	31	(32)	55	(47)	4	(21)	90	(39)

* 220 managers selected more than 1 category.

The majority of managers (84%, n=197) identified the need for education and training as a specific workforce development issue for their agency. Some managers (n=46) commented on specific issues such as education and training in new drug trends, the needs of specific population groups, and issues around mental health and dual diagnosis.

The need for more funding was expressed by 77% (n=180) of managers as a specific workforce development issue. Twenty four comments were recorded on the workforce development consequences of inadequate funding. Managers indicated that agencies were constrained by the cost of training and development, the cost of travel and attendance at conferences and the lack of resources to attract and retain staff, especially shift workers. One manager from NSW commented on the difference between levels of funding in government and non-government agencies:

“Funding to NGO treatment agencies must be increased to enable them to employ, train and improve workforce development to the levels available to government agencies.”
(NSW:601.2.19)

Over two thirds of managers (67%, n=157) also indicated the need for available workers to backfill staff positions. However, managers often qualified this response by stating that having sufficient core staff to fill existing positions was a higher priority than having a pool of casual staff to backfill.

The importance of professionalisation was highlighted by 60% (n=140) of managers. Although over half of the respondents were advocates of professionalisation, a substantial proportion of managers held a different view. One manager from WA stated:

“...we need to be careful, AOD treatment is best delivered from the community up – professionalisation would mean a more directive approach. This makes the field inaccessible to a lot of people ... and we would lose many outstanding workers.”
(WA:489.3.1)

Management support was another important workforce development issue identified by 58% (n=136) of managers. Several comments were recorded emphasising the need for management support structures and training.

Half the managers (50%, n=118) identified a need for an agency workforce development policy.

Managers noted the lack of suitable courses and training as a workforce development issue for their agency (45%, n=106). A few managers (n=7) commented on the lack of quality short-term training programs and quality alternatives to long-term university training.

Thirty nine percent (n=90) of managers indicated that providing staff with incentives to attend training, such as paid leave, fee payment and travel costs was a relevant workforce development issue for their agency.

Some managers continued to outline workforce development issues faced by their agency after completing the designated checklist. These responses were listed in the ‘other’ category. Twenty six managers, located throughout all states except the Australian Capital Territory, commented on the unique workforce development difficulties of agencies working in a rural location. For example, a Queensland manager stated that:

“... especially in rural/regional locations ... it is hard to find experienced people to do the supervising.” (QLD:409.3.2)

Other respondents further outlined the difficulties associated with inadequate funding, commenting on their agencies’ inability to employ trained and experienced staff and the difficulty in recruiting and retaining suitable staff. Non-recurrent funding was also highlighted as a major workforce development issue not only for individual agencies but for the sector as a whole.

Discussion

This study is the first comprehensive examination of specialist AOD treatment agencies in Australia. It provides an examination of service provision for the treatment and management of alcohol-related problems.

The study involved the managers of two thirds of the AOD specialist treatment service agencies listed on the 2001 COTSA database. It extends the findings of the COTSA census (Shand and Mattick, 2001) and the first report on the National Minimum Data Set (AIHW, 2002b) by focussing on agencies' services and managers rather than the clients.

The findings from this study are held to be widely representative of the field due to the sampling methods employed and high response rate. Key findings for treatment and management, service provision and workforce development are highlighted in this report. Quantitative and qualitative data were collected. Managers provided responses based on their own experiences and perceptions. Where relevant, agency data was reported. When these were unavailable managers often estimated figures based on their own observations and experience. The latter findings have been interpreted with care.

Although this study was undertaken to scope the specialist alcohol treatment workforce in reality it yielded more information about specialist alcohol and other drug agencies overall and particularly those catering for illicit drug problems. This largely reflects the long tradition in Australia of integrated service provision in which alcohol has not usually been addressed separately to drugs. It also reflects the emphasis placed on illicit drugs in comparison to alcohol.

Treatment philosophy and orientation

The study found that three quarters of AOD agencies supported a harm minimisation approach. The definition of harm minimisation used in the study was one that incorporated abstinence. Strongest support for harm minimisation was found among government agencies where nearly all managers (90%) reported support for harm minimisation. Less support, although still strong, was found among non-government agencies where three quarters of managers indicated that harm minimisation was their treatment philosophy. Just over half the private organisations indicated support for harm minimisation. Overall less than one in six agency managers reported an exclusively abstinence treatment approach. This finding reflects the broadening of treatment approaches and the shift away from abstinence only treatment options and adoption of a broader public health approach (Commonwealth of Australia, 1998).

Alcohol

A very high proportion of clients presenting to AOD specialist treatment agencies were reported to have alcohol-related problems. Managers estimated that nearly half of their clientele reported alcohol as their primary problematic drug and over half their polydrug using clientele also identified alcohol as part of their polydrug problem. These figures reveal a very high prevalence of alcohol-related presentations in specialist treatment agencies and highlight the need for a workforce that is skilled in the treatment and management of alcohol problems.

Nearly two thirds of the managers ranked alcohol as the “most problematic drug” amongst their clients, while only 11% of managers ranked heroin as clients’ “most problematic drug”.

The large difference between the proportion of managers who ranked alcohol and those who ranked heroin as the most problematic drug reinforces the position of alcohol as the most significant drug problem within the alcohol and other drugs field.

This is also consistent with the view of over two thirds of managers who reported anticipated increases in alcohol-related client presentations over the next three to five years. Similarly, very few managers reported recent or expected decreases in alcohol-related presentations. Approximately half the sample (51%) indicated that they would be able to manage and respond to future trends in alcohol presentations but also highlighted the need for alcohol-related education, prevention and early intervention.

Managers largely attributed recent and predicted future increases in alcohol-related presentations to binge drinking and/or drinking in specific populations. They also reported that an increased awareness of the harms associated with high risk alcohol consumption, and increased treatment seeking behaviour also contributed to an increase in alcohol-related presentations. Social problems such as unemployment and homelessness and the affordability and accessibility of alcohol were also identified as influential factors. As one manager stated:

“Societal trends, family dysfunction, family breakdown, poverty and a basic need for escapism all contribute to the increase in alcohol abuse.” (QLD:601.2.11)

The study’s findings also indicated that the treatment and management of alcohol-related problems are often closely linked with the treatment and management of polydrug use. Managers often reported that amphetamine use and polydrug use were increasingly associated with increases in alcohol-related presentations. Echoing this trend, the majority of agencies (75%) provided treatment for a combination of alcohol and other drug problems.

Relatively few agencies (14%) focused exclusively on alcohol-related problems. The combined focus of most treatment agencies highlights the difficulty in identifying the needs of the specialist alcohol workforce. The strong emphasis and concern directed towards illicit drugs also tends to mask the significance and dimension of alcohol-related problems in Australia.

Managers frequently suggested that it was difficult to capture accurate data on alcohol-related problems as clients often fail to recognise and report alcohol as a problem. Clients also present with a diverse range of alcohol and polydrug use patterns, as depicted in the schema of alcohol-related presentations shown in Figure 22.

Figure 22: A schema of alcohol-related presentations

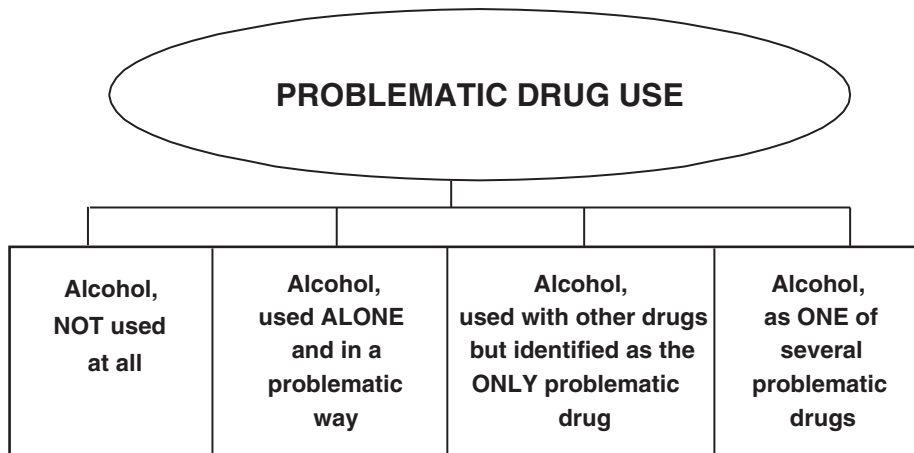

Key findings and implications

- *There is a high prevalence of alcohol-related presentations in specialist treatment agencies.*
- *Problematic alcohol use is increasingly associated with polydrug use.*
- *An increase in alcohol-related presentations is anticipated by most service managers.*
- *The extent of alcohol-related problems is often masked by a focus on illicit drugs.*

Alcohol and polydrug use

Managers indicated that clients are presenting with an increasingly diverse range of problems. The majority of managers predicted an increase in the number of polydrug-related presentations over the next three to five years. A range of possible reasons was highlighted for the increase in polydrug presentations including the heroin drought, an increase in the use of the different forms of amphetamine and the accessibility and affordability of alcohol and other drugs. The latter point, i.e. accessibility and affordability of both alcohol and other drugs, was an important recurrent theme among managers' concerns. One manager from NSW stated:

“As more drugs become socially acceptable and therefore easier to obtain, the chances of mixing and getting drugs previously unavailable or unacceptable are becoming more real.” (QLD:601.2.17)

Consistent with most national trend data the top five most problematic drugs reported by managers were:

- alcohol
- cannabis
- amphetamines
- heroin
- benzodiazepines.

The lower order placement of heroin as a problematic drug in the present study differs to the reporting of heroin in both the 2001 COTSA census and the 2000-2001 report on the National Minimum Data Set (AIHW, 2002b). A possible reason for the discrepancy in drug order is the timing of the present study. The end of 2001 saw a substantial decrease in the number of heroin related presentations as a result of the heroin “drought”. Data from the 2002 Illicit Drug Reporting System (IDRS) Drug Trends Bulletin (Breen et al., 2002) suggests that reported heroin use was lower in all states in 2001 compared to 2000. Reported heroin use continued to decline during 2002 in all states other than NSW, Queensland and Tasmania. Data collection for the present study commenced in April 2002 and managers' figures and estimates may reflect the residual effect of the heroin “drought”. Managers also suggested that people who used heroin moved to more accessible drugs during the drought.

Research also suggests that polydrug use is becoming the norm among many drug using clients (Swan and Ritter, 2001). This diversity in drug use is also recognised in the most recent Drug Trends Bulletin (Breen et al., 2002). For example, increasing diversity in drug type is seen among the amphetamine type stimulants. For instance, in 2002 the Illicit Drug Reporting

System recorded the use of powder, crystal and base methamphetamine in order to distinguish between the use of methamphetamine powder and other more potent forms (Breen et al., 2002).

In terms of capacity to cope with changing patterns and levels of problems, managers were slightly more likely to report that their agency would be able to manage alcohol trends (51%) than polydrug trends (46%). Some managers reported that their agencies were well resourced and could offer a range of services. These managers identified policies and strategies to meet community needs as integral components of their ability to manage and respond to alcohol and polydrug trends. One manager stated that:

“Policy gives you a great grounding... you can strategically respond to issues....agencies need to broaden their outlook, need a community outlook...not to be focused only on the individual client who comes through the door...you can refer on to other services.”
(NSW:246.4.12)

Managers who believed their agencies would not be able to manage future alcohol and polydrug trends referred to a range of factors affecting their ability to manage, including a lack of facilities, lack of qualified staff and the inability to retain staff, particularly in rural areas. Managers also expressed concern about clients using a diverse range of drugs with interactive and synergistic effects (e.g. alcohol and heroin).

Treatment of aggressive clients and clients experiencing psychotic episodes were some of the increasing challenges reported by the workers in the AOD field. It was consistently emphasised that the treatment and management of the complexities of polydrug use require a workforce with a different skill set to that which has been adequate to-date.

Key findings and implications

- *Treatment staff are increasingly required to develop skills in a broad range of treatment areas.*
- *Clients are presenting to specialist treatment agencies with increasingly complex treatment needs.*
- *Managers are under increasing pressure to be able to plan and develop the capacity of individual workers and agencies to carry out treatment programs to meet current and future needs of clients.*
- *Data collection systems of the specialist treatment agencies were often inadequate or incomplete. No standardised system for collection and recording of client data exists across Australia. The development of the National Minimum Data Set for Alcohol and Other Drug Treatment Services will result in continued improvement in the data collection of treatment agencies. Accurate data on patterns of client presentations and drug use is essential for agencies to plan and provide appropriate care.*

Service provision

Agencies offered a broad range of service delivery options including outpatient rehabilitation, outpatient withdrawal, inpatient rehabilitation, inpatient withdrawal and therapeutic community approaches. Most agencies offered more than one type of service. The majority of agencies (64%) offered outpatient rehabilitation and 33% of agencies provided outpatient withdrawal. Fewer agencies offered inpatient services, with 28% offering withdrawal and 27% offering inpatient rehabilitation. These findings are consistent with national and international trends away from inpatient toward outpatient care for AOD clients (Bao et al., 2001).

Inpatient and outpatient services have advantages and disadvantages. For example outpatient detoxification for clients with mild to moderate alcohol withdrawal is considered cheaper and less time consuming, while being as safe and effective as inpatient withdrawal (Hayashida, 1998). Inpatient services are now being targeted to more severely dependent people and those with other medical or social factors requiring greater supervision (Mattick & Hall, 1996). However, as Swan and Ritter (2001) point out, polydrug users withdrawing from multiple drugs (including alcohol) may be faced with more difficulties than those withdrawing from only one drug type. In these instances, detailed and expert assessment is required to provide treatment services that are most appropriate (Swan & Ritter, 2001).

Managers often reported a wide range of treatment options within their agencies. Counselling, referrals, assessment, education, followup services, crisis management, rehabilitation, withdrawal management and medication management were some of the treatments offered by over half of the agencies. Some managers also reported “other” additional services. This largely constituted community education, family counselling, outreach work and diversion programs.

Client access

Managers expressed concern that some sectors of the community did not have sufficient access to appropriate services. Access can be constrained by a range of factors including age, gender, ethnic background, location, time and financial constraints. Some managers also reported that community perceptions of treatment services might influence a potential client’s decision to access the services of a treatment agency. For example, one manager highlighted the reluctance of some middle-aged women with alcohol-related problems to use the services of an agency that also treated clients with illicit drug problems.

Youth

The need for more youth focused services to cater for the treatment needs of people aged under 18 and as young as 10 years was identified. Alcohol was seen as a growing problem among young people. Concern was often expressed about the capacity of agencies to meet the needs of clients under 18 years.

The treatment of AOD-related problems in young people can be more complex than the treatment of adult clients (Spooner et al., 2001). Research has shown the importance of recognising young problematic drinkers and providing education to encourage moderate use of alcohol among young people (Stockwell et al., 2001).

No agencies with an alcohol treatment focus provided specific youth oriented services. This is a concern given research that identifies youth to be at greatest risk of alcohol-related harm than any other age group (Stockwell et al., 2001). According to the 2001 National Drug Strategy Household Survey (AIHW, 2002a) 20% of males aged between 14 and 19 consume alcohol at high-risk levels at least monthly, compared to 15% of all age groups. Similarly 21% of females aged between 14 and 19 consume alcohol at a high-risk level at least once a month compared to 12% of all age groups. While not all of these high risk consumers would warrant specialist care, some would.

Some managers highlighted the need for peer workers to meet the needs of younger clients experiencing alcohol and other drug-related problems. These managers believed that peer workers with similar age and social characteristics were very effective in educating and treating young clients. Concomitantly, some older managers perceived their age to be an impediment to working with younger clients. The wide difference in age was reported to result in a “credibility” gap that precluded effective management of young clients.

Trend data indicate that the prevalence of problematic AOD use among young and very young people is increasing (AIHW., 2002a). The provision of appropriate services for young people, or lack thereof, is an area of growing concern. This issue has important workforce development implications and requires a proactive and systematic response in order to provide the most effective treatment options for young people.

Families

Some agencies identified a need to provide more support and/or therapy for the families of clients. Research has shown that families can be a significant influence on both patterns and problems associated with a person's drug use (Mitchell et al., 2001). There is a growing need to involve and support families of drug users (Swan & Ritter, 2001).

There are important resource implications in widening the provision of services to cater for families. At one level there are cost implications and at another there are important considerations in terms of the skill set of staff. Family therapy, for example can require different skills than one-on-one interventions.

Comorbidity

Clients with a co-occurring mental illness and AOD problems were also identified as having special treatment needs that were frequently not met by AOD specialist treatment agencies. As one manager highlighted:

“Dual diagnosis is a huge issue, I am essentially a mental health worker.....when AOD becomes problematic my role is to work out what's behind it.” (TAS:527.4.12)

Some managers reported that agencies are not always equipped to cope with clients presenting with drug-related problems and mental illness. One manager identified the need to find a solution to:

“The revolving door between AOD and mental health services.” (WA:487.4.12)

The increasing presentation of clients with psychosis and/or aggressive behaviour patterns places additional pressure on AOD staff and services. There is growing concern that clients may move between mental health and drug and alcohol services without co-ordinated care.

Only 6% of managers indicated that their agency provided dual diagnosis services despite research showing increasing levels of comorbidity for alcohol or drug problems and mental illness. Saunders and Robinson (2002) estimate that 25% of people with mental illness also engage in problematic alcohol or other drug use. The current data indicate that only a very small proportion of services offer integrated care in this area. In terms of on-the-ground service provision this stands out as an area warranting further attention.

Rural needs

The unique challenges for clients in rural and remote areas were also highlighted. Managers expressed concern about the extent to which rural clients' treatment needs are often constrained by physical access difficulties and local knowledge (i.e. fear of their problem “getting out”). In addition, rural and remote residents may have to travel to regional centres for inpatient services, with important implications for their access to aftercare and followup. While these issues can be difficult to address, other concerns such as infrequent outreach worker visits are amenable to remediation through increased funding and support.

These findings indicate the need for improvements in the delivery of treatment programs in rural areas and expanding options to allow workers to travel to the client's location in order to provide the most effective treatment, or supplementing treatment by phone and correspondence. The latter has been demonstrated to be particularly effective (Kavanagh et al., 1996).

Key findings and implications

- *Client access issues are important considerations for specialist treatment agency managers.*
- *The provision of appropriate services for priority groups, including youth, families, clients with dual diagnosis needs and clients located in rural areas, are areas of growing concern.*
- *A systematic approach is required to develop the capacity of the AOD sector to provide the most effective treatment options for a diverse range of clients.*

Funding

Most managers reported that their agency received inadequate funding. One in four indicated they were unable to manage present and future alcohol and polydrug trends with current funding levels. Funding constraints were identified by managers as the primary factor in an agency's ability to manage and respond to alcohol and polydrug trends. Many managers reported that inadequate funding impacted on the level of current and future service provision especially in the areas of prevention and intervention, mental health and outpatient services. Other constraints resulting from a lack of funding included an inability to recruit and retain staff, high staff client ratios, large workloads, limited facilities and inadequate bed numbers.

Perceptions of funding levels varied considerably according to the type and location of agency. Five out of six non-government agencies reported inadequate funding compared to approximately two thirds of government agencies. More managers of agencies located in non-metropolitan locations (78%) reported inadequate funding compared to managers in metropolitan areas (67%). The latter finding may indicate a need for closer examination of community needs and funding levels of agencies located outside the metropolitan areas. Rural and remote agencies often face unique obstacles to the successful delivery of treatment programs. Some managers discussed the difficulty of providing services over a wide geographic area, such as vehicle costs and staff travelling time.

Funding constraints also require managers to be highly strategic in planning for the long-term operation of their agency and to effectively and efficiently meet the needs of clients and staff. Many managers reported that long-term planning was difficult when funded for only a limited period of time with no guarantee of continued funding.

Others reported creating policies to identify community needs and meeting them through strategic planning as integral components of their ability to manage and respond effectively to both alcohol and polydrug trends. One manager from NSW indicated their agency's commitment to the community in the following terms:

"We are always evaluating and implementing new services. We network, we have a business plan and we take time to identify the priorities and provide feedback on what the community needs." (NSW:185.2.19)

Key findings and implications

- *Funding constraints were identified as the primary factor in an agency's ability to manage and respond to alcohol and polydrug presentations.*
- *Managers of government, non-government and private agencies reported different concerns regarding the adequacy of their level of funding.*
- *More non-government than government agencies reported inadequate levels of funding.*
- *More managers located in non-metropolitan areas reported inadequate levels of funding compared to managers in metropolitan areas.*
- *Managers' funding needs varied according to agency type and location. This has important workforce development implications especially for agencies located in rural areas and non-government agencies.*

Workforce issues

One of the objectives of the study was to determine the composition of the AOD workforce and scope the alcohol specific workforce. There is a need to identify characteristics of the AOD workforce in order to plan strategies to support ongoing development of workers. There is very little information available on the characteristics of the specialist or generalist AOD workforce in Australia (Roche, 2001). This scoping study aimed to provide more information on the AOD workforce.

The study found that the majority of specialist treatment agencies have a multi-skilled workforce who report being able to engage with clients with a wide range of alcohol or other drug problems. However, there was a small workforce oriented exclusively to alcohol-related problems within some specialist treatment agencies.

Agency managers

Most managers were relatively new to their role, with approximately half having been in their current managerial role for less than two years, although there was a very broad range in the number of years managers had worked in the field (1-40 years). Such a high proportion of relatively inexperienced managers in Australian AOD specialist treatment agencies is a matter for concern. Approximately 60% of managers identified the need for "more management support" as a workforce development issue for their agency. These findings suggest that management training is a priority need. To ensure optimal efficacy of treatment services, enhanced support and training for managers is warranted.

Staff of AOD agencies

The current study found that the single largest occupational group within the specialist treatment workforce was nurses, one in four workers was a nurse. The heavy reliance on nursing staff within the sector has had a detrimental effect on the ability of agencies to recruit staff due to the national nursing shortage. The largest occupational groups after nurses were general AOD workers, psychologists, counsellors and social workers.

Within the top five occupational groups, three come from university qualified professional backgrounds - nursing, psychology and social work. The remaining two groups of general

AOD workers and counsellors are broad classifications. A diverse range of workers came under these categories including recent university graduates from a range of disciplines, TAFE graduates and people with relevant life experiences including former drug users. Overall, more than 50% of staff classified as “therapeutic staff” came from university trained professional backgrounds. It is anticipated that the trend towards greater professionalisation of the workforce will continue in the future.

Staff development

The most popular staff development initiatives reported by managers were in-house training programs, supervision and conference/study leave. The types of staff development initiatives offered varied according to agency type. Private organisations were more likely to offer in-house training programs than non-government and government agencies. More government agencies were likely to offer study leave and conference leave than non-government and private agencies. The most common staff development initiative offered by non-government agencies was supervision. The high rate of supervision offered by non-government agencies has important implications for resources required to ensure that supervision is effective and of a high standard. The importance of supervision is increasingly emphasised (Kavanagh et al., 2002).

Managers reported a high rate of uptake for staff development opportunities with 74% of staff always or frequently taking advantage of these options. The majority of managers (66%) reported that their agencies’ staff development programs adequately prepared workers to respond to AOD issues. Some managers highlighted effective initiatives such as clinical supervision, mentoring, buddy systems and in-house training programs. Twenty two percent of managers reported that their agencies’ staff development programs do not adequately prepare workers to respond to AOD issues. Some of these managers described factors that impact on staff development such as time pressures on staff and lack of appropriate training for already highly skilled staff.

Staff vacancies

This study found that many agencies were operating with staff vacancies and two thirds reported difficulty filling staff vacancies. Greatest difficulty in filling vacancies was reported by government agencies located in non-metropolitan areas.

The most common reason given for difficulties in filling vacancies was lack of qualified and/or experienced workers, especially nurses. This was followed by the poor remuneration offered by the field. Importantly, the stigma attached to the working in the alcohol and other drugs area was also commonly noted by managers. The latter is an area in which there is considerable scope to undertake focused strategies to alter community and professional perception of working in this area.

Managers also identified recruitment/retention and career opportunity issues, such as lack of incentives, less incentive to work part time, short term contracts, no security, shift work and high workload, as detrimental to their ability to recruit staff and fill vacancies.

A smaller proportion of managers reported that their agency had no staff vacancies due to a stable workforce. A number of managers also indicated that their agency had good networks/links in the field, they had appropriate applicants apply and that people wanted to work at these agencies. Further research is warranted with agencies that reported a stable workforce and no difficulty filling vacancies to identify strategies and policies that could enhance workforce development across the sector.

Recruitment

Difficulty in recruiting staff was identified as a major concern for many managers. Lack of funding was often reported to be a factor contributing to problems in recruiting staff. Managers also reported a lack of suitable applicants and competition between agencies for staff.

Some managers in rural areas reported that they recruited inexperienced people from the local area and provided in-house training in order to establish a pool of workers. The view was also expressed that training and professional development of staff provided by many agencies was a cost that should be borne by government.

The survey collected data on the top three qualities managers looked for when recruiting employees. These were:

1. personal qualities (e.g. empathy, non-judgmental and common-sense)
2. AOD skills and experience
3. AOD qualifications.

A number of additional characteristics were also identified including organisational compatibility and other professional experience or qualifications. These findings imply that, along with the increasing shift to professionalisation of the AOD workforce, there is still a strong emphasis on the personal qualities of AOD workers.

There was a distinct polarisation in the views of managers regarding the employment of workers who had overcome an alcohol and/or other drug problem. Managers opposed to “ex-users” working in the field justified their opinion using examples of therapeutic bias, as one manager from WA stated:

“They think what worked for them will work for their clients.” (WA:494.3.2)

These managers also maintained that people from a recovered background still had their own issues and challenges that they faced daily and the chance of relapse contributed to instability in the workforce. Conversely, some managers reported that people who have previously had an alcohol or other drug problem are effective AOD workers as they had the best education and training available i.e. first hand experience. A Victorian manager stated:

“I’m one for using people who have been there and done it.”

A twelve month course and a book of theories is useless, compared to those who have been there done it and seen it first hand.” (VIC:270.3.2)

The polarisation of opinions regarding the employment of ex-users as AOD workers highlights the need for the AOD sector to develop workforce support structures to support all AOD workers.

Retention

Managers frequently discussed the difficulties involved in retaining staff. The inability to fund qualified or experienced employees, lack of suitable applicants and competition for staff between agencies were identified as factors that contribute to large workloads for remaining staff. Heavy workloads were identified as a significant contributory factor in staff burnout and also a major impediment to the uptake of training. Managers from all types of agencies expressed concern over staff burnout.

Key findings and implications

- *The conundrum of recruitment and retention of staff in specialist treatment agencies compounds workplace pressure.*
- *Recruitment and retention are significant workforce development issues.*
- *There is a need to identify and develop systems that support the participation of workers in the AOD sector and provide appropriate ongoing education and training for current workers.*

Workforce development

In recent years, the AOD sector has broadened its focus from education and training of individual workers to examine structural and systems factors, such as resources, policy, recruitment and retention strategies that impact on workplace performance (Roche, 2001). In the present study, managers were asked to describe their understanding of workforce development. Most managers' understanding of workforce development was one of traditional staff development and training with little appreciation of organisational and systems factors that may impact on workplace performance. Only a small proportion of managers responded that they were unsure about the meaning of workforce development.

Managers identified workforce development issues relevant to their agency. The most common issues cited were the need for education and training (e.g. in new drug trends, the needs of specific population groups, and issues around mental health and dual diagnosis), more funding, staff to backfill positions, the need for professionalisation of workers and more support for management.

Managers' identification of education and training as their primary workforce development concern supports research highlighting the need for education and training to ensure consistent quality of service provision and to cover existing gaps in knowledge and skills within the workforce (Roche, 1998).

Seventy seven percent of managers identified the need for more funding as a specific workforce development issue. Level of concern varied significantly according to agency type. More non-government agencies (87%) reported funding issues than government agencies (69%) or private agencies (53%). These results confirm findings discussed earlier regarding levels of funding in which more non-government agencies reported inadequate levels of funding compared to government agencies. Managers reported a range of consequences of funding constraints such as not being able to fund training and development of staff, an inability to fund travel and attendance at conferences and the lack of resources to attract and retain staff.

Funding is a structural factor impacting on workforce development with implications on the provision of adequate infrastructure and resources for agencies and for recruitment and retention of AOD workers. An important implication of inadequate and/or limited funding is the need for managers to develop strategies that enable the most effective and efficient use of limited financial and human resources. Many managers reported a need for staff to backfill positions. However they often qualified this response by stating that a higher priority was to have staff to fill existing positions rather than having a pool of casual workers to backfill.

The majority of managers indicated support for the professionalisation of workers. Some managers suggested that the introduction of compulsory completion of the Certificate IV in Community Services studies for all workers would be an appropriate step in this direction.

However, other managers expressed a lack of confidence in the competency of the TAFE system, indicating that the training and skill development alone does not adequately equip workers for the demands of working in the field.

The professionalisation of workers is a complex workforce development issue. Earlier research has raised the question of “who should be taught, what should be taught, how should it be taught and when we might know that it is effective” (Roche, 1998: 85). The type and level of education and training undertaken by workers can be important factors affecting work practices. Needs assessment and evaluation can identify the most appropriate education and training for agency workers to meet the needs of their clients and to develop their individual skills and knowledge. These findings have implications for best practice in AOD education and training.

In addition to the issue of professionalisation of AOD workers, the question was raised regarding the role of volunteers in the AOD sector and their education and training needs. Some managers expressed concern about the ethics of using unpaid volunteers when funding levels were inadequate.

Key finding and implication

- *Most managers’ understanding of workforce development was one of traditional staff development and training with little appreciation of organisational and system factors that may impact on workplace performance.*

Summary

There is a high prevalence of alcohol-related presentations in specialist treatment agencies. Managers reported that some clients present with alcohol only problems but increasingly problematic alcohol use is associated with polydrug use. An increase in alcohol-related presentations was anticipated by many managers. The full extent of alcohol-related problems is often and easily masked by a heavy emphasis on illicit drugs.

Staff are increasingly required to develop skills in a broad range of treatment approaches and types of services. Clients are presenting to specialist treatment agencies with increasingly complex treatment needs. There is a need for increased development of the capacity of individual workers and agencies in order to meet current and future needs of clients.

Data collection systems of specialist treatment agencies were often inadequate or incomplete. No standardised system for collection and recording client data exists across Australia. The development of the National Minimum Data Set for Alcohol and Other Drug Treatment Services will result in continued improvement in the data collection of treatment agencies. Accurate data on patterns of client presentations and drug use is essential for services to plan and provide appropriate care.

Client access issues are important considerations for specialist treatment agency managers. The provision of appropriate services for priority groups, including youth, families, clients with dual diagnosis needs and clients located in rural areas, is an area of growing concern. It has important workforce development implications. A systematic approach is required to develop the capacity of the AOD sector to provide the most effective treatment options for a diverse range of clients.

Funding constraints were identified as the primary factor in an agency’s ability to manage and respond to alcohol and polydrug presentations. Managers’ funding needs varied according to

agency type and location. This has workforce development implications especially for agencies located in rural areas and non-government agencies. Managers of government, non-government and private agencies reported different concerns regarding the adequacy of their level of funding. More non-government agencies than government agencies reported inadequate levels of funding. More managers located in non-metropolitan areas reported inadequate levels of funding compared to managers in metropolitan areas.

The conundrum of recruitment and retention of staff in specialist treatment agencies compounds workplace pressure. Recruitment and retention are significant workforce development issues. There is a need to identify and develop systems that support the participation of workers in the AOD sector and provide appropriate on-going education and training for current workers.

Most managers' understanding of workforce development was one of traditional staff development and training with little appreciation of organisational and systems factors that may impact on workplace performance.

Conclusion

This study is the first of its type to be undertaken in Australia. Its initial focus was on alcohol and the provision of services to address alcohol-related problems. However, because of the highly integrated nature of services in Australia it has also provided a wealth of information about all specialist treatment agencies. This study provides an important basis for future work of this type and offers important benchmark data not elsewhere available.

References

- Abouyanni, G., Stevens, L. J., Harris, M. F., Wickes, W. A., Ramakrishna, S. S., Ta, E., et al. (2000). GP attitudes to managing drug- and alcohol-dependent patients: a reluctant role. *Drug and Alcohol Review*, 19, 165-170.
- Adams, W. L., & Cox, N. S. (1995). Epidemiology of problem drinking among elderly people. *International Journal of the Addictions*, 30, 1693-1716.
- Ask, A., Ashenden, R., Allsop, S., Cormack, S., Addy, D., & Beel, A. (1998). *Education and training programs for frontline professionals responding to drug problems in Australia: A literature review*. Adelaide: National Centre for Education and Training on Addiction.
- Australian Institute of Health and Welfare. (1995). *1994 National Drug Strategy Household Survey: Urban Aboriginal and Torres Strait Islander Peoples Supplement*. Canberra: Australian Government Publishing Service.
- Australian Institute of Health and Welfare. (2002a). *2001 National Drug Strategy Household Survey: First results. AIHW cat. no. PHE 35*. Canberra: AIHW (Drug Statistics Series No. 9).
- Australian Institute of Health and Welfare. (2002b). *Alcohol and other drug treatment services in Australia 2000-01: First report in the National Minimum Data Set. Drug Treatment Series no.1 AIHW. Cat.no.HSE 22*. Canberra: AIHW.
- Ballard, R., Gillespie, A., & Irwin, A. (1994). *Principles for drug education in schools*. Canberra: University of Canberra.
- Bao, Y., Sauerland, D., & Sturm, R. (2001). Changes in alcohol-related inpatient care: An international trend comparison. *Journal of Addictive Diseases*, 20(2), 97-104.
- Bien, T. H., Miller, W. R., & Tonigan, J. S. (1993). Brief interventions for alcohol problems: A review. *Addiction*, 88, 315-336.
- Bien, T. H., Miller, W. R., & Tonigan, J. S. (1995). Brief intervention: A reply to a review of a review. *Addiction*, 90(8), 1120-1121.
- Breen, C., Degenhardt, L., & Roxburgh, A. (2002). *Drug Trends Bulletin, Illicit Drug Trends Reporting System December 2002*. Sydney: National Drug and Alcohol Research Centre.
- Brower, K. J., Mudd, S., Blow, F. C., Young, J. P., & Hill, E. M. (1994). Severity of treatment of alcohol withdrawal in elderly versus younger patients. *Alcoholism. Clinical and Experimental Research*, 18(1), 196-201.
- Bush, R. A., & Williams, R. J. (1988). Generalist health and welfare workers' response to alcohol related problems: role legitimacy and the need for role-support, and example from an Australian rural community. *Drug and Alcohol Dependence*, 22, 105-111.
- Caetona, R., & Cunradi, C. (2002). Alcohol dependence: A public health perspective. *Addiction*, 97, 633-645.
- Caldwell, T. M., Rodgers, B., Jorm, A. F., Christensen, H., Jacomb, P. A., Korten, A. E., et al. (2002). Patterns of association between alcohol and consumption and symptoms of depression and anxiety in young adults. *Addiction*, 97, 583-594.
- Chen, R., Mattick, R. P., & Baillie, A. (1992). *Clients of treatment service agencies: March 1992 census findings*. Sydney: Department of Health, Housing and Community Services.
- Chick, J. (2001). Pharmacological treatments. In N. Heather, T. J. Peters & T. Stockwell (Eds.), *Alcohol dependence and problems*. West Sussex: John Wiley and sons.
- Chikritzhs, T., Jonas, H., Heale, P., Stockwell, T., Dietze, P., Hanlin, K., et al. (2000). *Alcohol caused deaths and hospitalisations in Australia, 1990-1997*. Perth: National Drug Research Institute.

- Clement, S. (1986). The identification of alcohol-related problems by general practitioners. *British Journal of Addiction*, 81, 257-264.
- Collins, D. J., & Lapsley, H. M. (2002). *Counting the costs: Estimates of the social costs of drug abuse in Australia in 1998-9*. Canberra: Commonwealth Department of Health and Ageing.
- Commander, M. J., Odell, S. O., Williams, K. J., Sashidharan, S. P., & Surtees, P. G. (1999). Pathways to care for alcohol use disorders. *Journal of Public Health Medicine*, 21(1), 65-69.
- Commonwealth of Australia. (1998). *National Drug Strategic Framework 1998-99 to 2002-03*. Canberra: Commonwealth Department of Health and Aged Care.
- Commonwealth of Australia. (2001). *National alcohol strategy: A plan for action 2001 to 2003-2004*. Canberra: Commonwealth Department of Health and Aged Care.
- Community Drug Summit. (2001). *Broadening the provision of treatment for drug users through other human services, including health, justice, welfare and youth sectors, and its integration with specialist alcohol and drug services*. Perth: Community Drug Summit.
- Conigrave, K. M., Saunders, J. B., & Reznik, R. B. (1995). Predictive capacity of the AUDIT questionnaire for alcohol-related harm. *Addiction*, 90(11), 1479-1485.
- Cooney, N. L., Zweben, A., & Fleming, M. F. (1995). Screening for alcohol problems and at-risk drinking in health-care settings. In R. K. Hester & W. R. Miller (Eds.), *Handbook of alcoholism treatment approaches: Effective alternatives* (2nd ed.). Boston: Allyn and Bacon.
- Copeland, J. (1998). *Shared care in the management of alcohol and other drug-related disorders: A review of the literature*. Sydney: University of New South Wales.
- Copeland, J., Hall, W., Didcott, P., & Biggs, V. (1993). A comparison of a specialist women's alcohol and other drug treatment service with two traditional mixed-sex services: Client characteristics and treatment outcome. *Drug and Alcohol Dependence*, 32, 81-92.
- De Vaus, D. (1995). *Surveys in Social Research*, 4th ed. Sydney, Australia: Allen & Unwin.
- Degenhardt, L., Hall, W., Teesson, M., & Lynskey, M. (2000). *Alcohol use disorders in Australia: Findings from the National Survey of Mental Health and Well-Being*. Sydney: National Drug and Alcohol Research Centre.
- Doherty, S. J., & Roche, A. M. (2002). *Alcohol and licensed premises: Best practice in policing. A monograph for police and policy makers*. (In press).
- Donnelly, N., & Briscoe, S. (2002). Young adults' experience of responsible service practice in NSW. *Alcohol Studies Bulletin*, 3, 1-16.
- Durand, M. A. (1994). General practice involvement in the management of alcohol misuse: Dynamics and resistances. *Drug and Alcohol Dependence*, 35, 181-189.
- Dwyer, P. (1995). *Interim competency standards for the alcohol and other drugs (AOD) field in community services work (direct care/ casework)*. Sydney: Community Programs.
- Farmer, R., & Greenwood, N. (2001). General practitioners' management of problem drinkers-attitudes, knowledge and practice. *Drugs: Education, Prevention and Policy*, 8(2), 119-129.
- Farrell, G. C. (2002). *Hepatitis C, liver disorders and liver health: A practical guide*. Eastgardens: MacLennan and Petty.
- Fleming, M. F., Mundt, M. P., French, M. T., Manwell, L. B., Stauffacher, E. A., & Barry, K. L. (2002). Brief physician advice for problem drinkers: Long-term efficacy and benefit-cost analysis. *Alcoholism: Clinical and experimental research*, 26(1), 36-43.
- Fowler, G., Allsop, S., Melville, D., & Wilkinson, C. (1999). *Drug harm minimisation for police in Australia*. Canberra: Commonwealth of Australia.

- Graham, K., & Homel, R. (1997). Creating safer bars. In M. Plant, E. Single & T. Stockwell (Eds.), *Alcohol minimising the harm - what works*. London/New York: Free Association Books.
- Graham, R., Wodak, A. D., & Whelan, G. (2002). New pharmacotherapies for alcohol dependence. *Medical Journal of Australia*, 177, 103-107.
- Hayashida, M. (1998). An overview of outpatient and inpatient detoxification. *Alcohol Health and Research World*, 22(1), 44-46.
- Hester, R.K. & Miller, W.R. (1995). *Handbook of alcoholism treatment approaches: Effective alternatives (2nd ed.)*. Boston: Allyn and Bacon.
- Hodgson, R., Alwyn, T., John, B., Thom, B., & Smith, A. (2002). The fast alcohol screening test. *Alcohol and Alcoholism*, 37(1), 61-66.
- Holdcraft, L. C., & Iacono, W. G. (2002). Cohort effects on gender differences in alcohol dependence. *Addiction*, 97, 1025-1036.
- Holmwood, C. (2002). Alcohol-related problems in Australia: Is there a role for general practice? *Medical Journal of Australia*, 177, 102-103.
- Hornblow, A. (2002). *Workforce development: Barriers and possibilities*. Paper presented at the Catching clouds: Workforce Development Symposium, Adelaide.
- Institute of Medicine. (1990). *Broadening the base of treatment for alcohol problems: Report of a study by a committee of the Institute of Medicine, Division of Mental Health and Behavioral Medicine*. Washington, D.C.: Committee for the Study of Treatment and Rehabilitation Services for Alcoholism and Alcohol Abuse.
- Ireland, C. S., & Thommeny, J. L. (1993). The crime cocktail: Licensed premises, alcohol and street offences. *Drug and Alcohol Review*, 12, 143-150.
- Kavanagh, D. J., Sitharthan, T., & Sayer, G. P. (1996). Prediction of results from correspondence treatment for controlled drinking. *Addiction*, 91(10), 1539-1545.
- Kavanagh, D. J., Spence, S. H., Wilson, J., & Crow, N. (2002). Achieving effective supervision. *Drug and Alcohol Review*, 21(3), 247-252.
- Keller, S. D., & Dermatis, H. (1999). Current status of professional training in the addictions. *Substance Abuse*, 20, 123-140.
- Mattick, R. P., & Hall, W. (1996). Are detoxification programmes effective? *The Lancet*, 347, 97-100.
- McInnes, E., & Powell, J. (1994). Drug and alcohol referrals: Are elderly substance abuse diagnoses and referrals being missed? *British Medical Journal*, 308, 444-446.
- McLennan, W., & Madden, R. (1999). *The health and welfare of Australia's Aboriginal and Torres Strait Islander peoples. Catalogue No. 4704.0*. Canberra: Australian Bureau of Statistics.
- Midford, R., & McBride, N. (2001). Alcohol education in schools. In N. Heather, T. J. Peters & T. Stockwell (Eds.), *Alcohol dependence and problems*. West Sussex: John Wiley and sons.
- Miller, M., & Draper, G. (2001). *Statistics on drug use in Australia 2000*. Canberra: Australian Institute of Health and Welfare.
- Mitchell, P., Spooner, C., Copeland, J., Vimpani, G., Toumbourou, J., Howard, J. & Sanson, A. (2001). *The role of families in the development, identification, prevention and treatment of illicit drug problems*. Canberra: National Health and Medical Research Council (NHMRC).
- Mowbray, A., & Kessel, N. (1986). Alcoholism and the general practitioner. *British Journal of Psychiatry*, 148, 697-700.

- National Centre for Education and Training on Addiction. (1998). *Education and training programs for frontline professionals responding to drug problems in Australia*. Adelaide: NCETA.
- National Drug Strategy. (2002). *National alcohol research agenda*. Canberra: Commonwealth of Australia.
- Norman, R. (2001). Have you got an attitude problem? Caring for illicit drug-using patients. *Contemporary Nurse*, 10, 83-91.
- Norton, A. (1998). Alcohol-related crime: The good practice of the magistrate's courts. *Alcohol and Alcoholism*, 33(1), 78-82.
- O'Donovan, A., & Dawe, S. (2002). Evaluating training effectiveness in psychotherapy: Lessons for the AOD field. *Drug and Alcohol Review*, 21(3).
- Office of Torres Strait Islander Health. (2001). *Better health care: Studies in the successful delivery of primary health care services for Aboriginal and Torres Strait Islander Australians*. Canberra: Commonwealth of Australia.
- Ogborne, A. C., Braun, K., & Schmidt, G. (2001). Who works in addictions treatment services? Some results from an Ontario survey. *Substance Abuse and Misuse*, 36(13), 1821-1837.
- Pangbourne, S. (1995). Craving social support: The need for specialist treatment facilities for pregnant chemically dependent women. *Deakin Addiction Policy Research Annual*, 2, 17-21.
- Paton, A. (1996). Thoughts on 'Alcohol problems into the next century'. *Alcohol and Alcoholism*, 31(3), 231-234.
- Pitts, J. (2001). Identifying workforce issues within the alcohol and other drug sector: responses to a national survey. In A. M. Roche & J. McDonald (Eds.), *Systems, settings, people: Workforce development challenges for the alcohol and other drug field*. Adelaide: National Centre for Education and Training on Addiction.
- Proudfoot, H., & Teesson, M. (2000). *Investing in drug and alcohol treatment*. Sydney: National Drug and Alcohol Research Centre.
- Proudfoot, H., & Teesson, M. (2001). *Who seeks treatment for alcohol dependence?: Findings from the Australian National Survey of Mental Health and Wellbeing*. Sydney: National Drug and Alcohol Research Centre.
- Richmond, R. (1996). From research to policy: When cutting edge meets coalface. *Addiction*, 91(1), 35-37.
- Ridolfo, B., & Stevenson, C. (2001). *The quantification of drug-caused mortality and morbidity in Australia, 1998*. Canberra: Australian Institute of Health and Welfare.
- Roche, A. M. (1997). The shifting sands of alcohol prevention: Rethinking population control approaches. *Australian and New Zealand Journal of Public Health*, 21(6), 621-625.
- Roche, A. M. (1998). Alcohol and drug education and training: A review of key issues. *Drugs: Education, Prevention and Policy*, 5(1), 85-99.
- Roche, A. M. (1999). Binge drinking: The definitional dilemmas. *Health Promotion Journal of Australia*, 9(2), 128-132.
- Roche, A. M. (2001). What is this thing called workforce development? In A. M. Roche & J. McDonald (Eds.), *Systems, settings, people: Workforce development challenges for the alcohol and other drugs field*. Adelaide: National Centre for Education and Training on Addiction.
- Roche, A. M., & Deehan, A. (2002). Women's alcohol consumption: Emerging patterns, problems and public health implications. *Drug and Alcohol Review*, 21(2), 169-178.
- Roche, A. M., & Evans, K. R. (1998). The implications of drinking patterns for primary prevention, education and screening. In M. Grant & J. Litvak (Eds.), *Drinking patterns and their consequences*. Washington: Taylor & Francis.

- Roche, A. M., Hotham, E. D., & Richmond, R. L. (2002). The general practitioner's role in AOD issues: Overcoming individual, professional and systemic barriers. *Drug and Alcohol Review*, 21, 223-230.
- Roche, A. M., Parle, M. D., Campbell, J., & Saunders, J. B. (1995). Substance abuse disorders: Psychiatric trainees' knowledge, diagnostic skills and attitudes. *Australian and New Zealand Journal of Public Health*, 29, 645-652.
- Roche, A. M., Parle, M. D., & Saunders, J. B. (1996). Managing alcohol and drug problems in general practice: A survey of trainees' knowledge, attitudes and educational requirements. *Australian and New Zealand Journal of Public Health*, 20(4), 401-408.
- Roche, A. M., Parle, M. D., Stubbs, J. M., Hall, W., & Saunders, J. B. (1995). Management treatment efficacy of drug and alcohol problems: What do doctors believe? *Addiction*, 90, 1357-1366.
- Roche, A. M., & Richard, G. P. (1991). Doctors' willingness to intervene in patients' drug and alcohol problems. *Social Science and Medicine*, 33(9), 1053-1061.
- Roche, A. M., & Watt, K. (1999). Drinking and university students: From celebration to inebriation. *Drug and Alcohol Review*, 18, 389-399.
- Saunders, B., & Robinson, S. (2002). Co-occurring mental health and drug dependency disorders: Workforce development challenges for the AOD field. *Drug and Alcohol Review*, 21(3), 231-237.
- Saunders, J. B., Aasland, O. G., Babor, T. F., de la Fuente, J. R., & Grant, M. (1993). Development of the Alcohol Use Disorders Identification Test (AUDIT): WHO collaborative project on early detection of persons with harmful alcohol consumption: II. *Addiction*, 88(6), 791-804.
- Shand, F., & Mattick, R. P. (2002). Results from the 4th National Clients of Treatment Services Agencies census: Changes in clients' substance use and other characteristics. *Australian and New Zealand Journal of Public Health*, 26(4), 352-357.
- Shaw, S., Cartwright, A. K. J., Spratley, T., & Harwin, J. (1978). *Responding to drinking problems*. London: Croom Helm.
- Single, E., & Rohl, T. (1997). *The National Drug Strategy: Mapping the future*. Canberra: Ministerial Council on Drug Strategy.
- Sitharthan, T., & Kavanagh, D. J. (1996). Moderating drinking by correspondence: An evaluation of a new method of intervention. *Addiction*, 91(3), 345-355.
- Sladden, T. J., Hickey, A. R., Dunn, T. M., & Beard, J. R. (1998). Hepatitis C infection: Impacts on behaviour and lifestyle. *Australian and New Zealand Journal of Public Health*, 22(4), 509-511.
- Spooner, C., & McPherson, M. (2001). *In what ways do police contribute to the prevention and management of alcohol-related problems in NSW?* Sydney: National Drug and Alcohol Research Centre.
- Spooner, C. J., Hall, W., & Lynskey, M. (2001). *Structural determinants of youth drug use*. Canberra: Australian National Council on Drugs.
- Stein, M. D., Charuvastra, A., Maksad, J., & Anderson, B. J. (2002). A randomized trial of brief alcohol intervention for needle exchangers (BRAINE). *Addiction*, 97(6), 691-700.
- Stockwell, T., & Bolderston, H. (1987). Alcohol and phobias. *British Journal of Addiction*, 82, 971-979.
- Stockwell, T., Heale, P., Dietze, P., Chikritzhs, T., & Catalano, P. (2001). *Patterns of alcohol consumption in Australia*. Perth: National Drug Research Institute.
- Swan, A., & Ritter, A. (2001). *Clinical treatment guidelines for Alcohol and Drug clinicians. No 7.: Working with polydrug users*. Fitzroy, Victoria: Turning Point Alcohol and Drug Centre Inc.

- Swift, W., & Copeland, J. (1998). Treatment needs of women with alcohol and other drug problems: Experiences and views of Australian treatment personnel. *Drug and Alcohol Review*, 17, 59-67.
- Teesson, M., Clement, N., Copeland, J., Conroy, A., & Reid, A. (2000). *The measurement of outcome in alcohol and other drug treatment: A review of available instruments*. Sydney: National Drug and Alcohol Research Centre.
- Teesson, M., & Proudfoot, H. (2001). *Interventions for alcohol dependence, abuse and excessive drinking*. Paper presented at the National Workshop on Alcohol Research Priorities, Adelaide.
- Thom, B. (2001). A social and political history of alcohol. In N. Heather, T. J. Peters & T. Stockwell (Eds.), *Alcohol dependence and problems*. West Sussex: John Wiley and sons.
- Torres, M. I., Mattick, R. P., Chen, R., & Baillie, A. (1995). *Clients of treatment service agencies: March 1995 census findings*. Sydney: Department of Health, Housing and Community Services.
- Webster, P., Mattick, R. P., & Baillie, A. (1990). *Clients of treatment service agencies: March 1990 census findings*. Sydney: Department of Health, Housing and Community Services.
- Wechsler, H., & Rohman, M. A. (1982). Future caregivers' views on alcoholism treatment: A poor prognosis. *Journal of Studies in Alcohol*, 43(9), 939-955.
- Weller, D. P., Litt, J. C. B., Pols, R. G., Ali, R. L., Southgate, D. O., & Harris, R. D. (1992). Drug and alcohol related health problems in primary care - what do GPs think? *Medical Journal of Australia*, 156, 43-48.
- White, J. M. (2001). Cochrane reviews and evidence-based practice. In A. M. Roche & J. McDonald (Eds.), *Systems, settings, people: Workforce development challenges for the alcohol and other drugs field*. Adelaide: National Centre for Education and Training on Addiction.
- Wilk, A. I., Jensen, N. M., & Havighurst, T. C. (1997). Meta analysis of randomised control trials addressing brief interventions in heavy alcohol drinkers. *Journal of General Internal Medicine*, 12(5), 274-283.
- Wilkinson, C., Browne, M., & Dwyer, P. (2002). Partnerships: Imperative or illusion in workforce development. *Drug and Alcohol Review*, 21(3).
- Williams, R., & Vinson, D. C. (2001). Validation of a single screening question for problem drinking. *Journal of Family Practice*, 50(4), 307-312.

Appendix A: Survey instrument

Alcohol Workforce Scoping Project Manager Telephone Survey

INTERVIEWER: _____

LENGTH OF INTERVIEW: _____

NUMBER OF CALLS: _____

Hello, my name is _____ and I am ringing on behalf of the National Centre for Education and Training on Addiction (NCETA). NCETA is running a Commonwealth funded project to obtain a detailed picture of the specialist alcohol workforce. The project aims to inform Commonwealth alcohol and other drug workforce development policy. As part of the project, I am conducting interviews with managers of specialist drug and alcohol services.

The interview should take around 15 minutes, it consists of 4 sections. I'll ask you for some information about your agency, the workforce it employs and your opinion on workforce development within the agency. Finally, I'll ask for some demographic information. Do you have the time to go ahead with the interview now?

IF YES: Be assured that any information you provide will be treated in the strictest confidence and you will not be individually identifiable in the resulting review. You are, of course, entirely free to discontinue your participation at any time or to decline to answer particular questions.

IF NO: Can I book a more convenient time to do this with you? (If the individual refuses to be interviewed try and ascertain their reason and record it on the interview refusal chart).

The first section of the interview will look at the type of alcohol and other drug (AOD) services offered by your agency, its client base, treatment approach and funding level.

SECTION 1: ABOUT YOUR AGENCY

1.1 IS YOUR AGENCY A :

- GOVERNMENT ORGANISATION
- NON GOVERNMENT ORGANISATION
- PRIVATE ORGANISATION
- OTHER _____

1.2 DOES YOUR AGENCY PROVIDE AOD SERVICES FOR A SPECIFIC CLIENT GROUP? EG AGE, GENDER, ETHNICITY

- YES (PLEASE DESCRIBE) _____
- NO

1.3 HOW WOULD YOU DESCRIBE THE SERVICE YOUR AGENCY PROVIDES? FOR EXAMPLE, IS IT AN INPATIENT REHABILITATION SERVICE, A THERAPEUTIC COMMUNITY, AN OUTPATIENT WITHDRAWAL SERVICE ETC

- IN PATIENT REHABILITATION GO TO 1.4
- IN PATIENT WITHDRAWAL GO TO 1.4
- THERAPEUTIC COMMUNITY GO TO 1.4
- OUT PATIENT REHABILITATION GO TO 1.5
- OUT PATIENT WITHDRAWAL GO TO 1.5
- OTHER (PLEASE SPECIFY)

1.4 FOR RESIDENTIAL / IN-PATIENT SERVICES:

- WHAT IS THE AVERAGE NUMBER OF CLIENTS TREATED ANNUALLY?
- HOW MANY DRUG AND ALCOHOL BEDS SO YOU HAVE ON SITE?

1.5 FOR NON-RESIDENTIAL / OUT-PATIENT SERVICES:

- WHAT IS THE AVERAGE NUMBER OF CLIENTS TREATED ANNUALLY?

1.6 DOES YOUR AGENCY HAVE A WAITING LIST?

- YES GO TO 1.61
- NO GO TO 1.7

1.61 ON AVERAGE HOW LONG DO CLIENTS WAIT TO BE ADMITTED?

1.62 HOW MANY PEOPLE ARE PRESENTLY ON THE WAITING LIST?

1.63 WHY DO YOU THINK THERE IS A WAITING LIST?

1.7 DOES YOUR AGENCY DEAL PRIMARILY WITH PEOPLE WHO USE:

- ALCOHOL
- ILLICIT DRUGS
- COMBINATION

1.8 WHAT TYPE OF ALCOHOL AND OTHER DRUG TREATMENT SERVICES DOES YOUR AGENCY OFFER?

- CRISIS MANAGEMENT
- MEDICATION MANAGEMENT
- WITHDRAWAL MANAGEMENT
- COUNSELLING
- GROUP WORK / GROUP COUNSELLING
- METHADONE MAINTENANCE
- OTHER PHARMACOTHERAPIES
- ACCOMMODATION
- REFERRAL TO OTHER SERVICES
- ASSESSMENT
- EDUCATION
- WORK PROGRAMS
- SELF HELP PROGRAMS
- ALCOHOLICS ANONYMOUS
eg 12 step program (on site)
- REHABILITATION
- FOLLOW UP SERVICE

Please describe departments eg Health, Housing, Mental Health, Family & Youth Services, Centrelink, Inpatient/Outpatient, Detox/Rehab, NGO, GO, etc.

- OTHER (PLEASE SPECIFY)

1.9 WHICH APPROACH BEST DESCRIBES YOUR AGENCY’S RESPONSE TO ALCOHOL AND DRUG USE?

- A HARM MINIMISATION APPROACH THAT CAN INCLUDE ABSTINENCE
- EXCLUSIVELY ABSTINENCE / 12 STEP PROGRAM
- OTHER (PLEASE DESCRIBE)

1.10 CAN YOU COMMENT ON THE ADEQUACY OF YOUR FUNDING FOR ALCOHOL AND OTHER DRUG WORK?

- ADEQUATE GO TO SECTION 2
- INADEQUATE GO TO 1.10.1

1.10.1 IN WHAT WAYS DOES LACK OF FUNDING IMPACT ON YOUR AGENCY?

SECTION 2: ABOUT YOUR WORKFORCE

The second section collects information about how many staff your agency employs and their role, as well as whether any staff deal only with alcohol problems. This section also addresses patterns in alcohol and other drug use, identifying trends for alcohol and polydrug use.

2.1 INCLUDING YOURSELF, HOW MANY STAFF WORK FOR YOUR AGENCY?

2.2 HOW MANY OF THESE STAFF WORK DIRECTLY WITH CLIENTS WHO HAVE AOD PROBLEMS?

2.3 WE ARE INTERESTED IN IDENTIFYING THE COMPOSITION OF STAFF WHO WORK DIRECTLY WITH CLIENTS WHO USE ALCOHOL AND OTHER DRUGS. PLEASE RECORD STAFF NUMBERS IN THE BOXES BELOW. (NO FRACTIONAL APPOINTMENTS, JUST NUMBER OF STAFF)

- | | |
|---|--|
| <input type="checkbox"/> DOCTORS | <input type="checkbox"/> PEER WORKERS |
| <input type="checkbox"/> NURSES | <input type="checkbox"/> YOUTH WORKERS |
| <input type="checkbox"/> PSYCHIATRISTS | <input type="checkbox"/> GENERAL AOD WORKERS |
| <input type="checkbox"/> PSYCHOLOGISTS | <input type="checkbox"/> COUNSELLORS |
| <input type="checkbox"/> SOCIAL WORKERS | <input type="checkbox"/> FRONT DESK STAFF |
| <input type="checkbox"/> OTHER (Please provide the number of people for each additional category) | |

2.4 HOW MANY OF THESE STAFF WORK ONLY ON THE TREATMENT AND MANAGEMENT OF ALCOHOL PROBLEMS?

2.41 CAN YOU EXPLAIN WHY THIS IS THE CASE?

2.5 APPROXIMATELY WHAT PERCENT OF YOUR POLYDRUG USING CLIENTS REPORT ALCOHOL AS A PROBLEM? (IF UNABLE TO ANSWER THE QUESTION PLEASE GO TO 2.51.)

2.51 CAN'T ANSWER THIS QUESTION BECAUSE

2.6 WHAT PERCENTAGE OF CLIENTS WOULD REPORT ALCOHOL AS THEIR PRIMARY PROBLEMATIC DRUG? (IF UNABLE TO ANSWER THE QUESTION PLEASE GO TO 2.61.)

2.61 CAN'T ANSWER THIS QUESTION BECAUSE

2.7 IN HIERARCHICAL ORDER, WHAT DRUGS DO CLIENTS USUALLY DESCRIBE AS BEING MOST PROBLEMATIC FOR THEM? (1 = MOST PROBLEMATIC)

- | | |
|---|--|
| <input type="checkbox"/> ALCOHOL | <input type="checkbox"/> OPIATES |
| <input type="checkbox"/> TOBACCO | <input type="checkbox"/> SOLVENTS / INHALANTS |
| <input type="checkbox"/> CANNABIS | <input type="checkbox"/> METHADONE |
| <input type="checkbox"/> ECSTASY/DESIGNER DRUGS | <input type="checkbox"/> SUSTAINED RELEASE MORPHINE |
| <input type="checkbox"/> AMPHETAMINES | <input type="checkbox"/> OVER THE COUNTER MEDICATION |
| <input type="checkbox"/> HALLUCINOGENS | <input type="checkbox"/> PRESCRIPTION DRUGS |
| <input type="checkbox"/> HEROIN | <input type="checkbox"/> BENZODIAZEPINES |
| <input type="checkbox"/> COCAINE | <input type="checkbox"/> OTHER (PLEASE DESCRIBE) |

2.8 PLEASE INDICATE TRENDS IN ALCOHOL USE THAT YOU HAVE NOTICED OVER THE PAST YEAR.

- INCREASED
- DECREASED
- REMAINED THE SAME
- NOT SURE BECAUSE

2.9 WHAT IS THE BASIS FOR YOUR OBSERVATION?

2.10 WHAT TRENDS IN ALCOHOL USE DO YOU EXPECT OVER THE NEXT 3–5 YEARS?

- INCREASE
- DECREASE
- REMAIN THE SAME
- NOT SURE BECAUSE

2.11 WHAT IS THE BASIS FOR YOUR PREDICTION?

2.12 DO YOU BELIEVE YOU WILL BE ABLE TO MANAGE AND RESPOND TO THESE TRENDS EFFECTIVELY?

- YES
- NO
- UNSURE

2.13 CAN YOU EXPLAIN WHAT YOU MEAN?

2.14 OVER THE PAST YEAR, WHAT TRENDS HAVE YOU NOTICED IN RELATION TO POLYDRUG USE?

- INCREASED
- DECREASED
- REMAINED THE SAME
- NOT SURE BECAUSE

2.15 WHAT IS THE BASIS FOR YOUR OBSERVATION?

2.16 WHAT TRENDS IN POLYDRUG USE DO YOU EXPECT OVER THE NEXT 3 – 5 YEARS?

- INCREASE
- DECREASE
- REMAIN THE SAME
- NOT SURE BECAUSE

2.11 WHAT IS THE BASIS FOR YOUR PREDICTION?

2.18 DO YOU BELIEVE YOU WILL BE ABLE TO MANAGE AND RESPOND TO THESE TRENDS EFFECTIVELY?

- YES
- NO
- UNSURE

2.19 CAN YOU EXPLAIN WHAT YOU MEAN?

SECTION 3: YOUR OPINIONS

This section aims to identify issues that may enhance or prove a barrier to workforce development within your agency. It also aims to identify staff development and training needs, as well as some issues related to hiring staff.

3.1 WHAT DOES THE TERM WORKFORCE DEVELOPMENT MEAN TO YOU?

Ask 3.2 as an open question, allow interviewee to list own thoughts. Tick box/es interviewee mentions, record issues that are not on the list. When finished prompt with remaining answers.

3.2 WHAT ARE THE WORKFORCE DEVELOPMENT ISSUES FOR YOUR AGENCY? (TICK AS MANY OPTIONS AS APPROPRIATE)

- NEED FOR EDUCATION AND TRAINING
- NEED FOR AGENCY WORK FORCE DEVELOPMENT POLICY
- NEED FOR MANAGEMENT SUPPORT
- NEED FOR MORE FUNDING
- NEED FOR STAFF TO BACKFILL POSTS
- LACK OF SUITABLE COURSES / TRAINING
- NEED FOR THE PROFESSIONALISATION OF AOD WORKERS
- NEED FOR INCENTIVES TO ATTEND TRAINING
- OTHER (PLEASE SPECIFY)

3.3 WHAT SYSTEMS DO YOU HAVE IN PLACE FOR ALCOHOL AND DRUG STAFF DEVELOPMENT?

- NO FORMAL SYSTEMS (EG NO STAFF DEVELOPMENT BUDGET OR POLICY)
IF, DESPITE HAVING NO FORMAL SYSTEMS, YOU PROVIDE ANY OF THE INITIATIVES LISTED BELOW, PLEASE ALSO TICK THE RELEVANT BOXES.
- | | |
|---|--------------------------------------|
| <input type="checkbox"/> CONFERENCE LEAVE | <input type="checkbox"/> MENTORING |
| <input type="checkbox"/> FINANCIAL ASSISTANCE FOR STUDY | <input type="checkbox"/> STUDY LEAVE |
| <input type="checkbox"/> IN-HOUSE TRAINING PROGRAMS | <input type="checkbox"/> SUPERVISION |
| <input type="checkbox"/> OTHER (PLEASE DESCRIBE) | |

3.4 HOW FREQUENTLY DO STAFF MEMBERS UTILISE THESE OPPORTUNITIES?

- ALWAYS
 - FREQUENTLY
 - OCCASIONALLY
 - RARELY
 - NEVER (PLEASE DESCRIBE THE REASONS FOR THIS)
-

3.5 IN YOUR OPINION, DO THE STAFF DEVELOPMENT PROGRAMS SUPPORTED BY YOUR AGENCY ADEQUATELY PREPARE PEOPLE FOR RESPONDING TO ALCOHOL AND OTHER DRUG PROBLEMS IN THEIR DAILY WORK?

- YES
- NO
- UNSURE

3.51 COULD YOU EXPAND ON THAT?

3.6 IN THE PAST YEAR HAS YOUR AGENCY HAD ANY DIFFICULTY FILLING VACANCIES FOR AOD TREATMENT STAFF?

- YES GO TO 3.61
- NO GO TO 3.62

3.61 TO WHAT DO YOU ATTRIBUTE THAT DIFFICULTY?

3.62 CAN YOU EXPAND ON THIS?

3.7 WHAT 3 THINGS DO YOU LOOK FOR WHEN EMPLOYING STAFF TO WORK WITH CLIENTS WHO HAVE AN ALCOHOL OR OTHER DRUG PROBLEM?

1 _____

2 _____

3 _____

SECTION 4: INFORMATION ABOUT YOU

I have a few more questions relating to you, your background, your education and training, and the amount of time you've spent in your present position.

4.1 AGE:

4.2 GENDER: MALE FEMALE

4.3 JOB TITLE _____

4.4 PLEASE DESCRIBE THE MAJOR COMPONENTS OF YOUR JOB

4.5 IN TERMS OF THE PROFESSIONAL AND PERSONAL EXPERIENCES AND QUALIFICATIONS YOU BRING TO YOUR ROLE, WOULD YOU DESCRIBE YOURSELF AS A? (YOU CAN CHOOSE MORE THAN ONE OPTION.)

- HEALTH PROFESSIONAL (NURSE, GP, PSYCHIATRIST)
- HUMAN SERVICES WORKER
(SOCIAL WORKER, AOD WORKER, PSYCHOLOGIST)
- BUSINESS PERSON
(ADMINISTRATION, ACCOUNTANT, MANAGER WITH NO CLIENT CONTACT)
- RELEVANT PERSONAL EXPERIENCE IN THE FIELD
- ANOTHER WAY

4.6 HOW LONG HAVE YOU WORKED IN THE ALCOHOL AND DRUG FIELD?
(TO THE NEAREST YEAR)

4.7 HOW LONG HAVE YOU BEEN IN YOUR CURRENT POST?
(TO THE NEAREST YEAR)

4.8 HAVE YOU HAD ANY SPECIFIC MANAGERIAL EDUCATION, TRAINING, OR EXPERIENCE?

- YES GO TO 4.81
- NO GO TO 4.9

4.81 COULD YOU DESCRIBE THIS?

4.9 HAVE YOU RECEIVED ANY SPECIFIC ALCOHOL AND DRUG EDUCATION, TRAINING OR EXPERIENCE?

- YES GO TO 4.10
- NO GO TO 4.11

4.10 WHAT QUALIFICATION, IF ANY, DID YOU OBTAIN FROM THIS?

- NON-ACCREDITED TRAINING COURSES
- PROFESSIONALLY ENDORSED QUALIFICATION (EG POLICE / NURSING)
- ACCREDITED SHORT COURSE
- CERTIFICATE II IN COMMUNITY SERVICES (AOD WORK) TAFE
- CERTIFICATE III IN COMMUNITY SERVICES (AOD WORK) TAFE
- CERTIFICATE IV IN COMMUNITY SERVICES (AOD WORK) TAFE
- DIPLOMA IN COMMUNITY SERVICES (AOD WORK) TAFE
- ADVANCED DIPLOMA OF COMMUNITY SERVICES (AOD WORK) TAFE
- DIPLOMA (UNIVERSITY)
- ADVANCED DIPLOMA (UNIVERSITY)
- GRADUATE CERTIFICATE
- GRADUATE DIPLOMA
- MASTERS
- PHD / DOCTORATE
- OTHER (PLEASE DESCRIBE)

4.11 HOW HAVE YOU DEVELOPED YOUR KNOWLEDGE ABOUT HOW TO RESPOND TO AOD ISSUES?

This is the end of the survey. Is there anything else you would like to add about how alcohol fits into your service?

Thank you very much for your time. We expect the project will be completed by late 2002. The results will be available by request from NCETA. It is also expected that the results will be posted on the NCETA website. If you have any queries about the survey please don't hesitate to contact the project officers:

Katrina Wolinski
Phone: (08) 8201 7576
Email: katrina.wolinski@flinders.edu.au

Margaret O'Neill
Phone: (08) 8201 7538
Email: margaret.oneill@flinders.edu.au

The Alcohol Scoping Project
NCETA
Level 3B, Mark Oliphant Building
Science Park Adelaide, Bedford Park SA 5042
Email: nceta@flinders.edu.au Website: www.nceta.flinders.edu.au

Appendix B: State breakdowns

Table 26: Type of treatment agency by state/territory

STATE	Government	Non Government	Private
SA	9	9	1
TAS	3	6	0
VIC	13	19	3
ACT	1	6	0
NSW	44	37	7
QLD	24	16	4
NT	3	8	1
WA	1	16	3
Total	98	117	19

Table 27: Type of service provided by agency by state/territory

State	Outpatient rehabilitation	Outpatient withdrawal	Inpatient r ehabilitation	Inpatient withdrawal	Therapeutic Community	Other
SA	12	5	6	4	4	0
VIC	20	16	8	10	6	1
TAS	7	4	1	1	1	0
ACT	2	1	4	3	2	0
NSW	56	25	18	27	13	5
QLD	27	17	16	12	4	1
NT	7	5	5	2	1	0
WA	18	5	6	6	4	0
Total	149	78	64	65	35	7

Table 28: Adequacy of funding by state/territory and organisation (n=232)

State	Government		Non Government		Private		Total
	Adequate	Inadequate	Adequate	Inadequate	Adequate	Inadequate	
SA	5	4	2	7	1	0	19
TAS	1	2	0	6	0	0	9
VIC	2	11	5	14	1	2	33*
ACT	1	0	0	6	0	0	7
NSW	17	26	4	33	4	2	86*
QLD	10	14	4	12	3	1	44
NT	0	3	2	6	1	0	12
WA	0	1	2	14	1	2	20
Total	36	61	19	98	11	7	232

* Denotes 1 set of missing data for each state

Table 29: Difficulty filling vacancies by state/territory and organisation

State	Government		Non Government		Private		Total
	Yes	No	Yes	No	Yes	No	
SA	7	2	4	4	1	0	18*
TAS	2	1	1	5	0	0	9
VIC	11	2	14	4	1	2	34*
ACT	1	0	6	0	0	0	7
NSW	26	18	24	13	4	3	88
QLD	16	8	8	7	2	2	43*
NT	3	0	5	3	1	0	12
WA	1	0	6	10	3	0	20
Total	67	31	68	46	12	7	231

* Denotes 1 set of missing data for each state