





The Family Focus Toolkit has been developed by Eastern Drug & Alcohol Service (EDAS) as part of the Family Focus Project. This multi-faceted project has a number of objectives including:

- ✓ Increasing treatment opportunities and resources for families affected by alcohol and other drug issues
- ✓ Providing resources for Family Workers within the Alcohol & Other Drug (AOD) Sector
- ✓ Increasing knowledge of family inclusive practice within the AOD sector through resources and professional development
- ✓ Providing drug education to non-AOD Family & Youth Workers.

ACKNOWLEDGEMENTS

EDAS would like to acknowledge the contribution of the following individuals and organisations in the development of this toolkit.

Department of Health & Ageing as the funding body for the Family Focus Project under the Non-Government Organisations Treatment Grants Program.

Family Focus Project Steering Committee:

- Stefan Gruenert - Odyssey House Victoria
- Angela Ireland - Family Drug Help
- Anne Iversen – Family Drug Help
- Naomi Rottem - The Bouverie Centre
- Tom Stylli - *each* Social & Community Health.

ABOUT EDAS

Eastern Drug & Alcohol Service (EDAS) provides alcohol and other drug counselling and support to adults, young people, families and people with acquired brain injuries in the Eastern Metropolitan Region of Melbourne.

The EDAS Family Program offers support to families, parents, grandparents, siblings, children, carers, friends and significant others of problematic substance users.





THE TOOLKIT

The Toolkit for AOD Family Work is a collection of selected resources including screening tools, questionnaires, worksheets, and utility practice tools gathered from the sector, research and professional bodies.

Each tool was chosen by the Family Focus Project Team for its relevance to both clinicians and clients of the EDAS Family Service.

How to use the Toolkit

The Toolkit is divided into five areas:

- Family work framework and assessment
- Families where there is problematic parental substance use
- Coping Assessment
- Concurrent Disorders
- Family Violence

Each tool has a prefacing page outlining the following:

- ✓ Author/s and references
- ✓ Origin of the tool / original developer
- ✓ Suggestions for use of the tool.

A list of additional resources and references are found on the final pages of the Toolkit.





CONTENTS

	Page
A Simple Guide to Genograms Standard Symbols for Genograms <i>Network of Alcohol & other Drugs Agencies (NADA)</i>	7–11
A Simple Framework for Working with Families <i>The Bouverie Centre</i>	12–13
<ul style="list-style-type: none"> • First Session Framework • Managing Subsequent Sessions • Conducting a Family Session Checklist 	
Single Session Work <i>The Bouverie Centre</i>	14–18
<ul style="list-style-type: none"> • Pre-SSW Client Questionnaire • Post-SSW Client Questionnaire 	
The Family CAGE – An Alcoholism Screening Test <i>Price & Emshoff</i>	20
Circles of Harm and Safety <i>Department of Human Services</i>	21-23
Family Problem Communication Index <i>McCubbin, Thompson & McCubbin</i>	21-23
The Parent / Caregiver Drug Issues Checklist Risk Assessment with Parental Drug Use <i>DrugNet</i>	24–27
The Coping Questionnaire <i>Orford, Templeton, Velleman & Copello</i>	29–31
How Concurrent Disorders Affect Family Life <i>O’Grady & Skinner</i>	33-37
<ul style="list-style-type: none"> • The Personal Impact Log • The Preoccupation & Impact Scale • The Family Concurrent Index of Concerns Quiz 	
Family Violence – Preliminary Assessment Tool <i>Department of Victorian Communities</i>	39-43
Resources	45
References	46





FAMILY WORK FRAMEWORK & ASSESSMENT



A SIMPLE GUIDE AND STANDARD SYMBOLS FOR GENOGRAMS

Network of Alcohol & other Drugs Agencies, (2009), *Tools for Change: A new way of working with families and carers*, Department of Health, NSW

http://www.nada.org.au/index.php?option=com_content&task=view&id=96&Itemid=25

These resources were accessed from the *Tools for Change* toolkit developed by the Network of Alcohol and other Drugs Agencies (NADA) as part of the Mental Health and Drug and Alcohol Family and Carer Project.

A Simple Guide to Genograms

A genogram or family tree is a useful tool to gather information about a client's family. (The 'client' is defined as the person in counselling. This could be the substance user and/or family members.) This visual representation of a family can help to identify patterns or themes within families that may be influencing or driving the client's current behaviour.

Many clients enjoy the opportunity to talk about their family history, and this can work as a good tool to build trust and rapport in a working relationship. However some clients may find seeing a visual representation/illustration of their relationships confronting, particularly if the majority of relationships in their life at present are conflictual or distant. Sensitive use of this tool will be useful to help promote healthy change and the development of more positive relationships in the client's life.

This process is also used to identify key family members who can be included in recovery plans, particularly those who are seen to be supportive. Also, family members who have displayed resilience in the face of addiction can be identified and acknowledged. (Kina Family and Addictions Trust, 2005)

With the client

- Aim to gather information about three generations: the client's generation, the parent, and the grandparents.
- Include significant others who lived with or cared for the family.
- Start with drawing the family structure; who is in the family; in which generations; how they are connected (birth, marriage, deaths etc).
- Ask them to tell you a bit about each person.
- As the client talks about family members and relationships, make a note alongside the name.
- Ask about relationships between family members
 - Who are you closest to?
 - What is/was your relationship like with...?
 - How often do you see...?
 - Where does...live now?
 - Is there any one here that you really don't get along with?
 - Is there anyone else who is very close in the family? Or who really don't get along?
- Ask about characteristics or habits of family members: health issues, drug and alcohol use, physical and mental health, violence, crime/trouble with the law, employment, and education. These are then added to the diagram. The effect of this is to emphasise the pervasive impact of addiction and can stimulate a desire to halt the family cycle of drug and alcohol problems (Kina Family and Addictions Trust, 2005). It is important, however, not to assume that there are drug and alcohol and mental health problems within the family history.
- Ask about family values, beliefs and traditions.
- Try to explore patterns and themes.
 - Who are you most like?
 - What is...like? Who else is like them?

Standard Symbols for Genograms

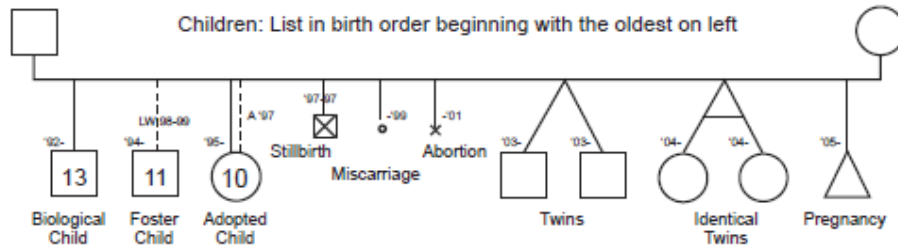
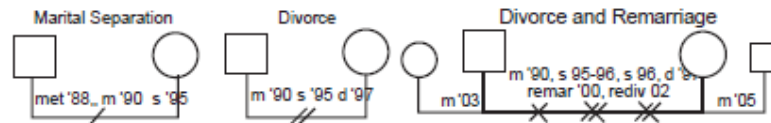
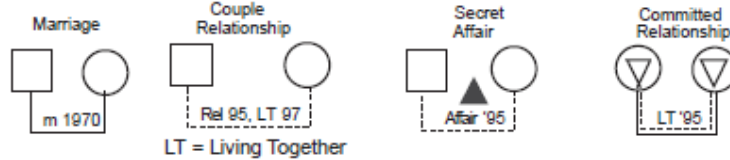
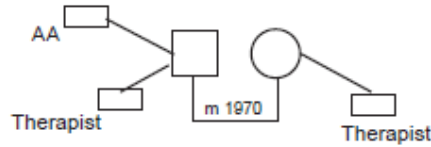
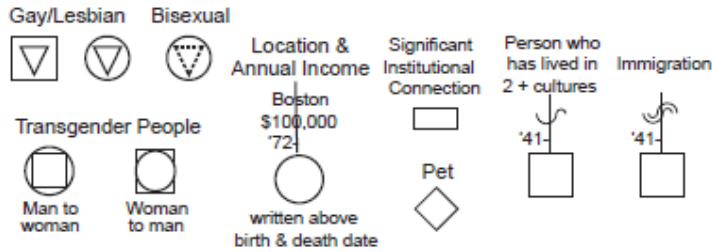
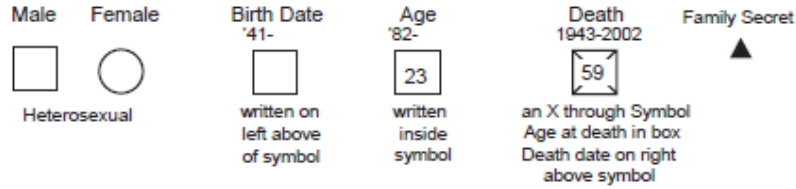

Symbols Denoting Addiction, and Physical or Mental Illness

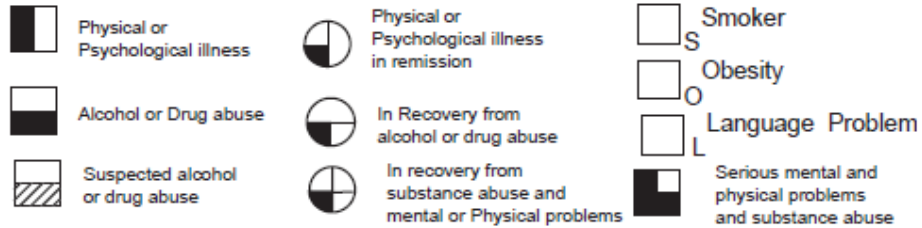

Symbols Denoting Interactional Patterns between People

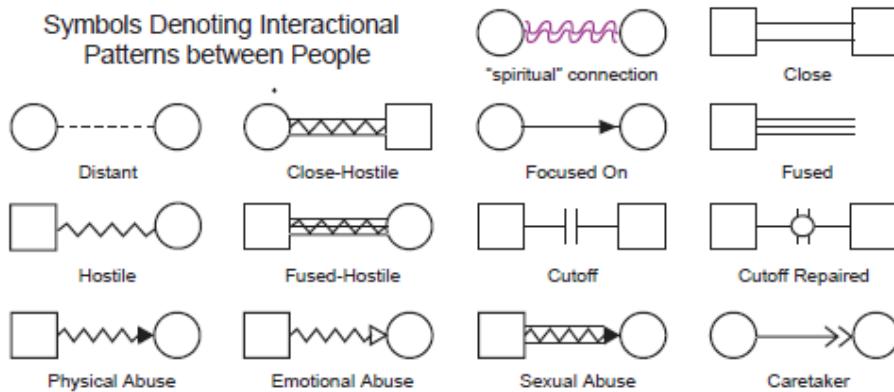

Annual income is written just above the birth & death date.

Typically you would include the person's occupation and education near the name and the person's whereabouts at the top of the line connecting to the symbol.

Symbol for Immigration = 

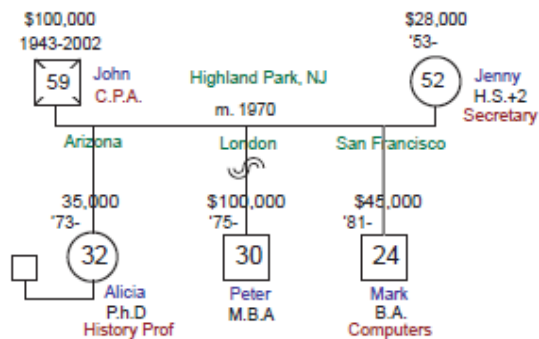

Artificial Insemination

Lesbian couple whose daughter was conceived with egg of one partner and sperm donor.

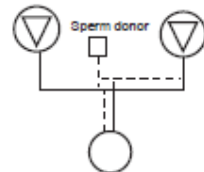

Gay Couple whose daughter was conceived with sperm of John and an egg donor, and carried by surrogate mother till birth.

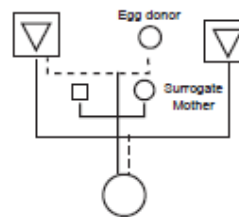

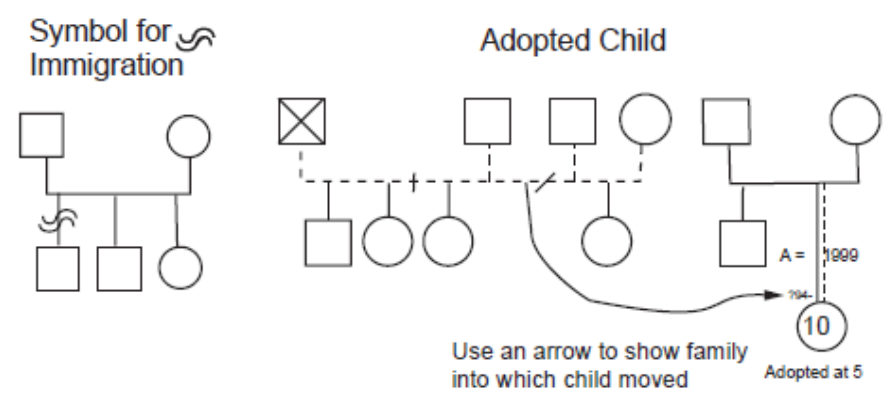
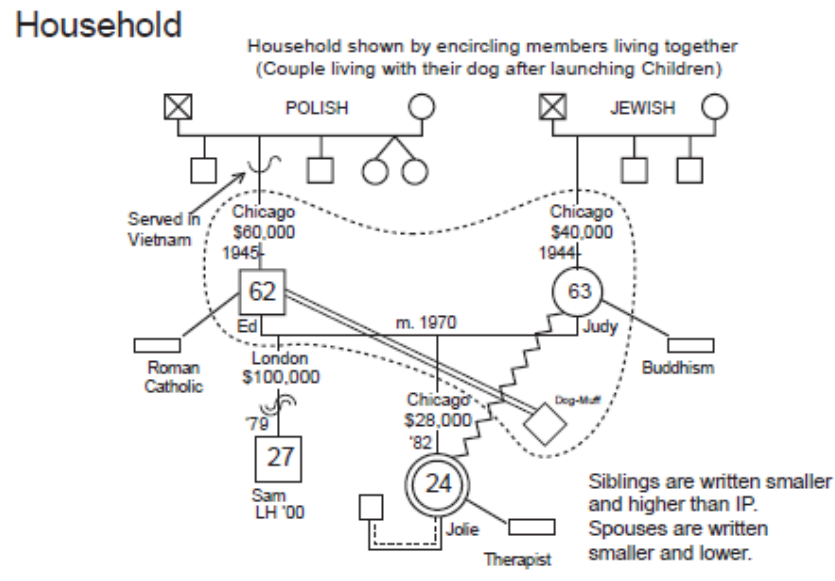
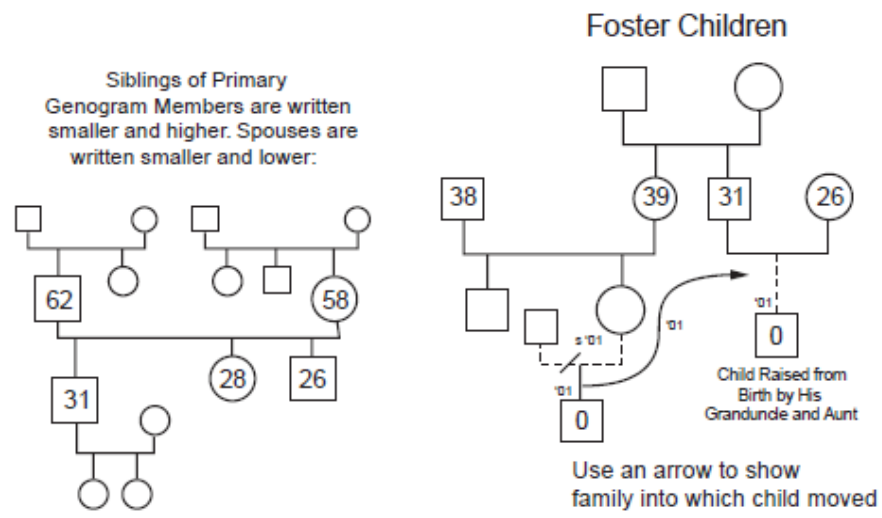

- 1 Husband, His Current Wife and his Ex-Wives (who are shown lower and smaller). Husband's wives may go on left to be closest to him. Indicators "1st," "2nd" etc. make clear the order of his marriages.

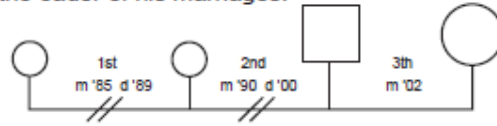

- 2 Wife, Her Current Husband and her Ex-Husbands (who are shown lower and smaller). Wife's previous relationships are shown on left to keep children in birth order, since they remained in her custody.

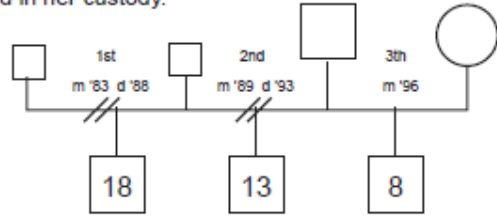

- 3 Couple with 3 year old, showing their previous spouses (smaller) and those spouses' new partners (even smaller)

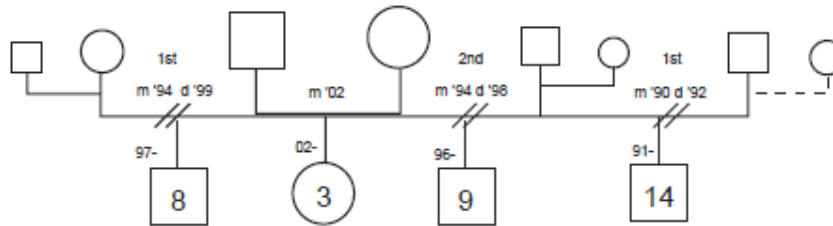

- 4 Couple living with their joint child and her child from a previous relationship. The other spouses of the partners are shown smaller and lower on either side of the present household, indicated by a dotted line.

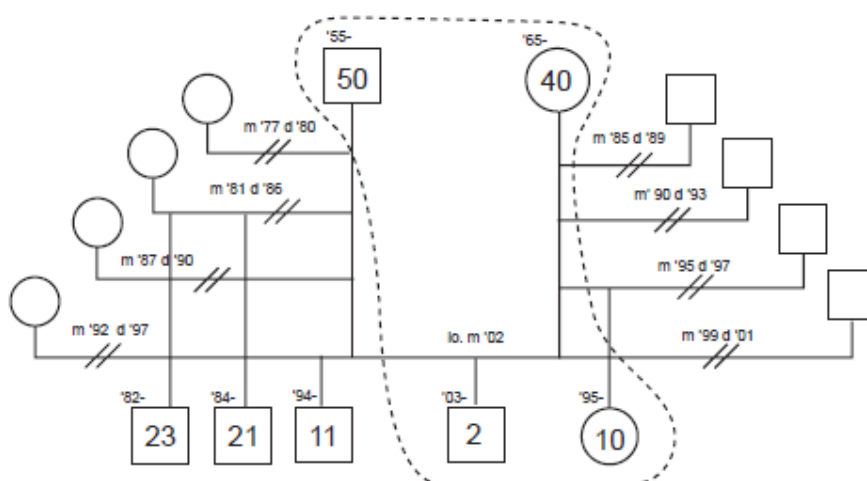

A SIMPLE FRAMEWORK FOR WORKING WITH FAMILIES

Proctor, K., Young, J. & Weir, S., (2006), *Focus on Families: Building confidence to work with families and significant others*, The Bouverie Centre

The following three resources were accessed from The Bouverie Centre's *Focus on Families* continuing education course workbook and are part of a two-day training program. The resources are reproduced with the permission of Shane Weir, Community Services Team Manager.

1. First Session Framework for Working with Families

This framework follows the practice principles of Single Session Work and shows the broad stages of this work with families. The framework is helpful with preparing and managing the different stages of the family session. A family session can follow the structure of a meeting:

- The worker sets their agenda for the meeting.
- Time is then taken to make all the family members feel comfortable.
- Each family member is asked what they would like to discuss.
- The worker regularly checks in to ensure the agreed agenda is on target.
- Each family member is assisted to relate directly and respectfully to each other throughout the meeting.

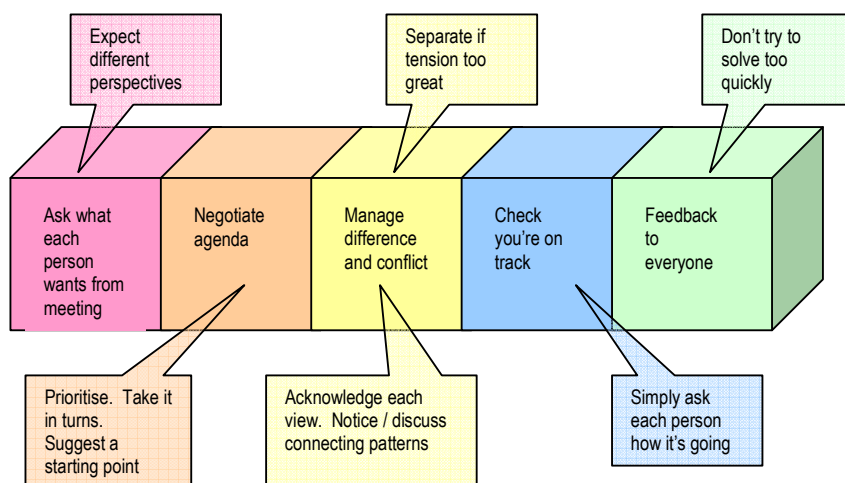

2. Managing Subsequent Sessions: Ongoing Framework for Working with Families

This framework again follows the Single Session Work and outlines the stages of subsequent family meetings.

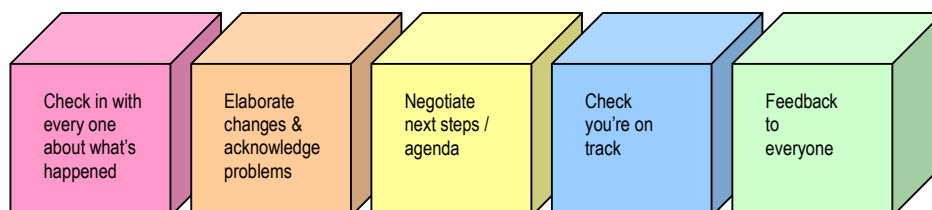

3. Conducting a Family Session Checklist

The Family Session Checklist

Welcome

- Welcome and thank the family for attending.
- State or re-state your agenda for the meeting.
- Invite other agenda items
- Identify any limitations – time, scope of possible outcomes.

Make Comfortable

- Communicate assumption that family members are doing the best they can.
- Acknowledge their difficult situation.
- Normalise their reactions and concerns.
- Encourage each person to contribute.
- Acknowledge family strengths.

Be Curious

- Approach the family with an open mind.
- Maintain a position of 'not knowing', i.e. be curious.
- Try to understand the unique perspective of each person present (step into each person's shoes)

Tolerate Difference / Predict Difference

- Expect that each person will have a different point of view.
- Accept each point of view rather than feel you have to decide the correct view.
- Articulate and share different points of view. This simple action can be very helpful.
- Facilitate productive interaction / interconnectedness.
- Explore how different points of view inter-relate.
- Point out similar concerns.
- Identify unhelpful patterns (vicious cycles).

Check In

- Check in to see if you are on course.
- Ask if meeting is being helpful.
- Ask if there is anything you should have asked about but haven't.

Clarify Progress and Next Step

- Clarify what is resolved and what is not.
- State plans to address unresolved issues.
- Emphasise positive outcomes.
- Provide tentative advice and clear feedback.
- Thanks family for attending and clarify next steps.

SINGLE SESSION WORK (SSW) – PRE & POST-SSW CLIENT QUESTIONNAIRES

Young, J., Rycroft, P. & Weir, S., (2006), *Single Session Work*, The Bouverie Centre

The following two questionnaires were accessed from The Bouverie Centre's *Single Session Work* continuing education course workbook and are part of a two-day training program. The resources are reproduced with the permission of Shane Weir, Community Services Team Manager.

The Pre-Single Session Work (SSW) and Post-SSW Client Questionnaires are part of the Single Session Framework which follows a set process:

- i. Initial Letter to Client
- ii. Pre-SSW Client Questionnaire
- iii. Letter to Referrer
- iv. Take Aways
- v. SSW Summary
- vi. Post-SSW Client Questionnaire
- vii. SSW Phone Follow-Up Form
- viii. SSW Evaluation Letter
- ix. SSW Evaluation Form
- x. SSW Worker Questionnaire

These questionnaires are useful tools to assist clients to focus on identifying goals they would like to explore / achieve in the session and to evaluate the efficacy of the work.

Ideally the client fills out the Pre-SSW Client Questionnaire before the first session.

The Post-SSW Client Questionnaire within the SSW Framework is completed during a follow-up phone consultation.

Outside the Single Session Framework, the questionnaires are useful guides to address and review treatment goals during the course of therapy.

Pre-SSW Client Questionnaire

Welcome. To assist us to maximise the effectiveness of the consultation, please complete the following questionnaire and bring it with you to your session.

There are different ways to fill out the questionnaire; some families call a family meeting to fill it out, some families photocopy it and everyone fills out their own questionnaire and sometimes only the person who requested the consultation fills it out. Do what suits your family.

Name of person(s) filling out the questionnaire:

.....

What are the main issues that bring you to this service?

(a) Greatest problem:

.....

(b) Second greatest problem:

.....

How upset / worried are you about these problems? (Place a cross on the line)

|-----|-----|-----|-----|-----|-----|-----|-----|-----|
(1) Not at all As worried as I could possibly be (10)

How often do these problems happen?

|-----|-----|-----|-----|-----|-----|-----|-----|-----|
(1) Not at all All the time (10)

Are there other difficulties you are coping with now? Please outline below.

.....

How much is the problem (or problems) interfering in your life?

|-----|-----|-----|-----|-----|-----|-----|-----|-----|
(1) Not at all It is dominating my life completely (10)

What made you decide that now was the right time to seek help?

.....

.....

.....

Pre-SSW Client Questionnaire cont.

How confident do you feel in dealing with the problem(s)?

_____	_____	_____	_____	_____	_____	_____	_____	_____	_____
-------	-------	-------	-------	-------	-------	-------	-------	-------	-------

(1) Not at all Extremely (10)

If casework / counselling was successful, what would you / you and your family be doing differently?

.....

.....

.....

.....

Since you first contacted the centre, what have you noticed happening to you (and your relationships with others) that you would like to keep happening in the future?

.....

.....

.....

.....

Often when people are in a stressful situation it is easy to forget to ask all of the questions you want to ask. Therefore we suggest you list the major questions you would like addressed below.

.....

.....

.....

.....

Post-SSW Client Questionnaire

To be filled out at follow-up or review. (In the SSW Framework, this questionnaire would be filled out during a phone follow-up consultation, in association with the Follow-Up Form – not included here.)

Name of person(s) responding to this questionnaire:

.....

You nominated:

.....

.....

.....

as the main problem which brought you to counselling, and

.....

.....

.....

as your second greatest problem.

♣ How upset / worried are you about this problem (or these problems) at the present time? (Place a cross on the line)

|-----|-----|-----|-----|-----|-----|-----|-----|-----|
(1) Not at all As worried as I could possibly be (10)

☆ How often do these problems happen?

|-----|-----|-----|-----|-----|-----|-----|-----|-----|
(1) Not at all All the time (10)

⊗ How much is the problem (or problems) interfering in your life?

|-----|-----|-----|-----|-----|-----|-----|-----|-----|
(1) Not at all It is dominating my life completely (10)

In what ways?

.....

.....

🎯 How confident do you feel in dealing with the problem(s)?

--	--	--	--	--	--	--	--	--	--

(1) Not at all Extremely confident(10)

You nominated the following questions as those you would like addressed within the Single Session:

.....

.....

.....

To what extent do you feel these questions were addressed?

.....

.....

.....

Office use only:

	Pre-session	Post-session	Difference
♣ How upset / worried:
☆ Problem frequency:
⚙ Life interference:
🎯 Confidence:

Client willing to be sent Client Satisfaction Survey (tick if applicable)



FAMILIES WHERE THERE IS PROBLEMATIC PARENTAL SUBSTANCE USE



THE FAMILY CAGE: AN ALCOHOLISM SCREENING TEST

Price, A.W., & Emshoff, J.G., (1997), *Breaking the Cycle of Addiction: Prevention and intervention with children of alcoholics*, Alcohol Health & Research World Vol.21, No.3, pp241-246.

This tool was accessed from the Deakin University Library and is embedded in a research article by Price and Emshoff as referenced above.

The original CAGE screening tool is a set of four questions regarding the substance user's concern about their own drinking behaviour. The Family CAGE follows the same principles but is specifically designed to screen for concerns about the drinking habits of a parent.

The tool is useful particularly when working with children of substance users to gauge initial reflections, concerns and thoughts about parental substance use. It is a screening tool only and if the results are positive, it is recommended further assessment of the family situation occurs to assist with treatment planning.

The Family **CAGE**

1. Do you think your parent needs to **CUT** down on his/her drinking?
2. Does your parent get **ANNOYED** at comments about his/her drinking?
3. Does your parent ever feel **GUILTY** about his/her drinking?
4. Does your parent ever take a drink early in the morning as an **EYE** opener?

THE CIRCLES OF HARM AND SAFETY

Department of Human Services, (2006), *Parenting Support Toolkit for Alcohol and Other Drug Workers*, Victorian Government Publishing Service. Available at: <http://www.health.vic.gov.au/drugservices/pubs/parenting-support.htm>

The '*Circles of Harm and Safety*' template was accessed from the Parenting Support Toolkit for Alcohol and Other Drug Workers as referenced above.

This tool can be used with parents who want to explore ways to minimise the potential impact of their substance use on their children. It can be used to highlight and document a parent's strengths and the things they are already doing to ensure this. The tool may be used in additional ways including:

- As part of motivational interviewing
- As a whiteboard exercise
- As a homework activity.

THE FAMILY PROBLEM COMMUNICATION INDEX

Department of Human Services, (2006), *Parenting Support Toolkit for Alcohol and Other Drug Workers*, Victorian Government Publishing Service. Available at: <http://www.health.vic.gov.au/drugservices/pubs/parenting-support.htm>

McCubbin, H. I., Thompson, A. I., & McCubbin, M. A., (1996), *Family problem-solving communication (FPSC)*, in *Family Assessment: Resiliency, Coping and Adaptation*, Inventories for Research and Practice., 639-684, Edited by McCubbin HI, Thompson AI, McCubbin MA. Madison, University of Wisconsin Press.

The *Family Problem Communication Index* was accessed from the Parenting Support Toolkit for Alcohol and Other Drug Workers as above.

The Family Problem Solving Communication Index is a 10-item measure of family communication patterns. The measure explores two types of communication patterns:

- inflammatory (incendiary) communications that exacerbate family stress; and
- affirming communications that convey caring and support that exert a calming influence.

This measure takes less than 5 minutes to complete and is a useful exploration of communication exchanges between parents and their children.

Circles of Harm and Safety

In each circle: list 1 or 2 good things that you currently do to minimise the harm that your drug use has on your kids; list 1 or 2 things you currently do that are not-so-good for the well-being of your kids, and then list 1 or 2 things that you could do to make things safer for your kids. Remember to describe specific things that someone else could see you doing.

Life Style Acquiring Drugs

Good things:

Not so good:

Child safety:

Intoxication Using Drugs

Good things:

Not so good:

Child safety:

Good things:

Not so good:

Child safety:

Withdrawal Coming down from drugs

Family Problem Solving Communication Index

When our family struggles with problems or conflicts which upset us, I would describe my family in the following way:

	False	Mostly False	Mostly True	True
1. We yell and scream at each other.	0	1	2	3
2. We are respectful of each others' feelings.	0	1	2	3
3. We talk things through till we reach a solution.	0	1	2	3
4. We work hard to be sure family members were not hurt, emotionally or physically.	0	1	2	3
5. We walk away from conflicts without much satisfaction.	0	1	2	3
6. We share with each other how much we care for one another.	0	1	2	3
7. We make matters more difficult by fighting and bringing up old matters.	0	1	2	3
8. We take the time to hear what each other has to say or feel.	0	1	2	3
9. We work to be calm and talk things through.	0	1	2	3
10. We get upset, but we try to end our conflicts on a positive note.	0	1	2	3

McCubbin, Thompson & McCubbin, (1996)

To score this scale:

Reverse score items 3 & 9.

For Affirming Communication: sum items 2, 4, and 6,8,10.

For Incendiary Communication: sum items 1, 3,5,7,9.

THE PARENT/CARE-GIVER DRUG ISSUES CHECKLIST - RISK ASSESSMENT WITH PARENTAL DRUG USE

DrugNet (1997), *Risk Assessment with Parental Drug Use*, DrugNet Professional Drug Management for Clinicians & Educators

This tool was accessed from the internet:

<http://www.drugnet.bizland.com/assessment/checklis1.htm>

The Parent/Care-Giver Drug Issues Checklist outlines seven key domains which can be used as part of a risk assessment with parental substance use. These domains were developed by the Standing Conference on Drug Abuse (SCODA) and the Local Government Drugs Forum (LGDF) for use by non-specialist professionals in England, Scotland and Wales.

The four scoring categories developed for the DrugNet site aim to broaden a 'yes/no' response and to identify evidence of positive parenting as well as potential child safety issues. The numerical system is a general guide only. Higher scores indicate increased risk and concern. Standardised or validated assessment of the sum totals of this checklist has NOT been developed. The comments section should be used to summarise the assessment from each of the domains.

This tool can be used as a guide towards exploring risk in the therapeutic conversation, where problematic parental substance use is a potential issue for the family.

Parent / Care-Giver Drug Issues Checklist

Key to scoring

Numbers are only intended to discriminate between protective factors, concerns and more serious issues which require immediate intervention.

-1 = **Positive** (positive – congratulate)

1 = **Transitional** (somewhat an issues)

2 = **Problematic** (requires immediate attention)

? = **Unsure** (further information required or not applicable)

The Pattern of Parental Drug Use

Is there a drug-free parent, supportive partner or relative?	-1	1	2	?
Is the drug use by the parent: Experimental? Recreational? Chaotic? Dependent?	-1	1	2	?
Does the user move between categories at different times? Does the drug use also involve alcohol <i>or a combination of drugs</i> ?	-1	1	2	?
Are the levels of care different from when the parent is/was a non-user?	-1	1	2	?
Is there any evidence of co-existence of mental health problems alongside the drug use? If there is, do the drugs cause these problems, or have these problems led to the drug use?	-1	1	2	?
Comments:				

Accommodation and Home Environment

Is the accommodation adequate for children?	-1	1	2	?
Are parents ensuring that rent and bills are paid?	-1	1	2	?
Does the family remain in one area or move frequently? If the latter, why?	-1	1	2	?
Are other drug users sharing the accommodation? If they are, are relationships with them harmonious, or is there conflict?	-1	1	2	?
Is the family living in a drug using community?	-1	1	2	?
If parents are using drugs, do children witness the taking of the drugs, or other substances?	-1	1	2	?
Could other aspects of the drug use constitute a risk to children (eg. conflict with or between dealers, exposure to criminal activities related to drug use)?	-1	1	2	?
Does the alcohol or other drug use contribute to any domestic violence issues?	-1	1	2	?
Comments:				

Provision of Basic Necessities

Is there adequate food, clothing and warmth for the children?	-1	1	2	?
Are the children attending school regularly?	-1	1	2	?
Are children engaged in age-appropriate activities?	-1	1	2	?
Are the children's emotional needs being adequately met?	-1	1	2	?

Are there any indications that any of the children are taking on a parenting role within the family (eg. caring for other children, excessive household responsibilities, etc.)?	-1	1	2	?
Comments:				
Procurement of Drugs				
Are the children being left alone while their parents are procuring drugs?	-1	1	2	?
Because of their parent's drug use, are the children being taken to places where they could be "at risk"?	-1	1	2	?
How much are the drugs costing?	-1	1	2	?
How is the money obtained?	-1	1	2	?
Is this causing financial problems?	-1	1	2	?
Are the premises being used to sell drugs?	-1	1	2	?
Are the parents allowing their premises to be used by other drug users?	-1	1	2	?
Comments:				
Health Risks				
If drugs and/or injecting equipment are kept on the premises, are they kept securely?	-1	1	2	?
Are the children aware of where the drugs are kept?	-1	1	2	?
If the parents are intravenous drug users: * Do they share injecting equipment? * Do they use a needle exchange scheme? * How do they dispose of syringes? * Are parents aware of the health risks of injecting or using drugs?	-1	1	2	?
If parents are on a substitute prescribing program, such as methadone: * Are parents aware of the dangers of children accessing this medication? * Do they take adequate precautions to ensure this does not happen?	-1	1	2	?
Are parents aware of, and in touch with, local specialist agencies that can advise on issues such as needle exchanges, substitute prescribing programs, detox and rehabilitation facilities? If they are in touch with agencies, how regular is the contact?	-1	1	2	?
Comments:				
Family's social networks & support systems				
Do parents and children associate primarily with: * Other drug users? * Non-users * Both?	-1	1	2	?
Are relatives aware of the drug use? Are they supportive?	-1	1	2	?

Will the parents accept help from the relatives?	-1	1	2	?
Will the parents accept help from statutory/non-statutory agencies?	-1	1	2	?
<i>The degree of social isolation should be considered particularly for those parents living in remote areas where resources may not be available and they may experience social stigmatisation.</i>				
Comments:				
The parents' perception of the situation				
Do the parents see their drug use as harmful to themselves or to their children?	-1	1	2	?
Do the parents place their own needs before the needs of their children?	-1	1	2	?
Are the parents aware of the legislative and procedural context applying to their circumstances, (eg. child protection procedures, statutory powers, other legal issues)?	-1	1	2	?
Comments:				
Other child safety issues		Other positive parenting issues		
Overall summary of findings:				
Negotiated recommendations and goals:				
Source (Parent/Care-Giver, neighbour): Case Worker		Dated: Review Date:		

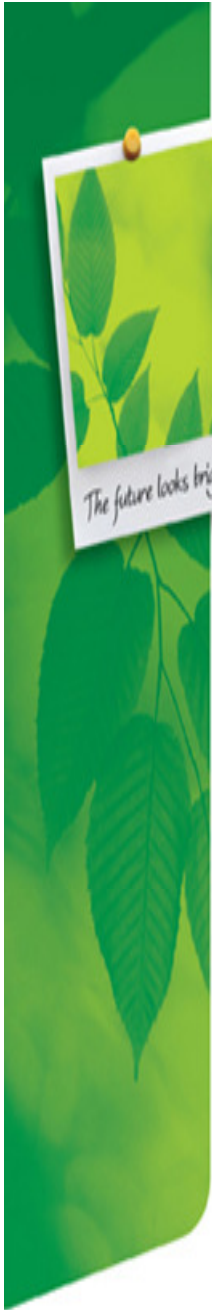

COPING ASSESSMENT



THE COPING QUESTIONNAIRE – 30 ITEM FORM

Orford, J., Templeton, L., Velleman, R. & Copello, A., (2005), *Family Members of Relatives with Alcohol, Drug and Gambling Problems: A set of standardised questionnaires for assessing stress, coping and strain*, *Addiction*, 100 (11), pp 1611-1624.

Reproduced with the permission of Professor Jim Orford. Copyright: Alcohol, Drugs, Gambling and Addiction Research Group, School of Psychology, The University of Birmingham.

The Coping Questionnaire is used to obtain information about how a family member is coping with their relative's alcohol or other drug use. The questionnaire has also been adapted for families where problem gambling is an issue. The questionnaire comes in two versions – relating to a male substance user and the other to a female. (The latter is the version found in this toolkit.)

The Coping Questionnaire explores three main ways of coping:

1. Engaged Coping – standing up to the problem
2. Tolerant Inactive Coping – putting up with the problem
3. Withdrawal Coping – withdrawing from the problem and gaining independence.

This questionnaire is useful as a tool within a semi-structured family session and draws out:

- areas for treatment planning;
- information towards developing creative solutions to current issues; and
- self-care goals.

The Coping Questionnaire

Have you recently (in the last 3 months)		Please circle one answer			
1	Refused to lend her money or to help her out financial in other ways?	NO	ONCE OR TWICE	SOMETIMES	OFTEN
2	Put the interests of other members of the family before hers?	NO	ONCE OR TWICE	SOMETIMES	OFTEN
3	Put yourself out for her, for example by getting her to bed or by clearing up mess after her after she had been drinking?	NO	ONCE OR TWICE	SOMETIMES	OFTEN
4	Given her money even when you thought it would be spent on drink?	NO	ONCE OR TWICE	SOMETIMES	OFTEN
5	Sat down together with her and talked frankly about what could be done about her drinking?	NO	ONCE OR TWICE	SOMETIMES	OFTEN
6	Started an argument with her about her drinking?	NO	ONCE OR TWICE	SOMETIMES	OFTEN
7	Pleaded with her about her consumption of alcohol?	NO	ONCE OR TWICE	SOMETIMES	OFTEN
8	When she was under the influence of drink, left her alone to look after herself or kept out of her way?	NO	ONCE OR TWICE	SOMETIMES	OFTEN
9	Made it quite clear to her that her drinking was causing you upset and that it had got to change?	NO	ONCE OR TWICE	SOMETIMES	OFTEN
10	Felt too frightened to do anything?	NO	ONCE OR TWICE	SOMETIMES	OFTEN
11	Tried to limit her drinking by making some rule about it, for example forbidding drinking in the house, or stopping her bringing drinking friends home?	NO	ONCE OR TWICE	SOMETIMES	OFTEN
12	Pursued your own interests or looked for new interests or occupation for yourself, or got more involved in a political, church, sports or other organisation?	NO	ONCE OR TWICE	SOMETIMES	OFTEN
13	Encouraged her to take an oath or promise not to drink?	NO	ONCE OR TWICE	SOMETIMES	OFTEN
14	Felt too hopeless to do anything?	NO	ONCE OR TWICE	SOMETIMES	OFTEN
15	Avoided her as much as possible because of her drinking?	NO	ONCE OR TWICE	SOMETIMES	OFTEN
16	Got moody or emotional with her?	NO	ONCE OR TWICE	SOMETIMES	OFTEN
17	Watched her every move or checked up on her or kept a close eye on her?	NO	ONCE OR TWICE	SOMETIMES	OFTEN
18	Got on with your own things or acted as if she wasn't there?	NO	ONCE OR TWICE	SOMETIMES	OFTEN

Have you recently (in the last 3 months)

Please circle one answer

19	Made it clear that you won't accept her reasons for drinking, or cover up for her?	NO	ONCE OR TWICE	SOMETIMES	OFTEN
20	Made threats that you didn't really mean to carry out?	NO	ONCE OR TWICE	SOMETIMES	OFTEN
21	Made clear to her your expectations of what she should do to contribute to the family?	NO	ONCE OR TWICE	SOMETIMES	OFTEN
22	Stuck up for her or stood by her when others were criticising her?	NO	ONCE OR TWICE	SOMETIMES	OFTEN
23	Got in a state where you didn't or couldn't make any decision?	NO	ONCE OR TWICE	SOMETIMES	OFTEN
24	Accepted the situation as a part of life that couldn't be changed?	NO	ONCE OR TWICE	SOMETIMES	OFTEN
25	Accused her of not loving you, or of letting you down?	NO	ONCE OR TWICE	SOMETIMES	OFTEN
26	Sat down with her to help her sort out the financial situation?	NO	ONCE OR TWICE	SOMETIMES	OFTEN
27	When things have happened as a result of her drinking, made excuses for her, covered up for her, or taken the blame yourself?	NO	ONCE OR TWICE	SOMETIMES	OFTEN
28	Searched for her drink or hidden or disposed of it yourself?	NO	ONCE OR TWICE	SOMETIMES	OFTEN
29	Sometimes put yourself first by looking after yourself or giving yourself treats?	NO	ONCE OR TWICE	SOMETIMES	OFTEN
30	Tried to keep things looking normal, pretended all was well when it wasn't or hidden the extent of her drinking?	NO	ONCE OR TWICE	SOMETIMES	OFTEN

Scoring Key

Score each item	NO = 0	ONCE OR TWICE = 1	SOMETIMES = 2	OFTEN = 3
FOR TOTAL (CQ-TOT) COPING, sum all 30 items				
FOR ENGAGED COPING SUB-SCALE (CQ-E), sum score for items: 1, 5, 6, 7, 9, 11, 13, 16, 17, 19, 21, 25, 26, 28				
FOR TOLERANT COPING SUB-SCALE (CQ-T), sum scores for items: 3, 4, 10, 14, 20, 23, 24, 27, 30				
FOR WITHDRAWAL COPING SUB-SCLAE (CQ-W) sum scores for items: 2, 8, 12, 15, 18, 29 <u>and</u> subtract scores for items 5 and 22: and then add 6 (to ensure all values for CQ-W are positive)				
(N.B. – Item 5 contributes positively to CQ-TOT and CQ-E, but negatively to CQ-W)				



CONCURRENT DISORDERS



HOW CONCURRENT DISORDERS AFFECT FAMILY LIFE

O'Grady, C.P. & Skinner, W.J., (2007), *A Family Guide to Concurrent Disorders*, Centre for Addiction and Mental Health

Additional references: Kashner TM, Rader LE, Rodell DE, et al, (1991), *Family characteristics, substance abuse, and hospitalization patterns of patients with schizophrenia*, *Hospital and Community Psychiatry* 42:195-196.

The tools were accessed from the *Family Guide to Concurrent Disorders* resource manual as referenced above.

The following three tools assist families to gauge the impact of concurrent disorders of substance abuse and mental illness on the family. The tools can be self-administered within session or as homework tasks, or can be used as a method of exploration and discussion in session.

1. **The Personal Impact Log** assists with exploring the effects of concurrent disorders on the family's physical, emotional, social and spiritual health. The log helps to break down the overall impact of the family member's life into smaller and more manageable areas of concern. This log is particularly useful when creating a self-care plan for family members.
2. **The Preoccupation and Impact Scale** assists with exploring thoughts, fears and worries about the family member with the concurrent disorder. This scale has not been tested and therefore the score should not be interpreted. Rather it should be used as a tool to elicit how much the preoccupation effect has infiltrated the family's life. The scale can also elicit the family member's move from a constant state of preoccupation to an emotionally healthier, calmer and more balanced lifestyle.
3. **The Family Concurrent Index of Concerns Quiz** assists with exploring and pinpointing areas of concern. The quiz may also help to:
 - Identify personal areas of concern over which the family client may have little control;
 - Consider how the family client might learn to accept what they cannot change; and
 - Identify opportunities for change.

1. The Personal Impact Log

On the personal impact log, write down ways your life has been affected in the areas that apply to you. You may find that you fill in only some of the areas. You will use this information to help you to develop a self-care plan.

An example of a personal impact log:

PERSONAL IMPACT LOG	
Physical Health	Emotional Health
<ul style="list-style-type: none"> • Chest pain has returned – too worries about my son • No time to go to my own doctor anymore • No longer exercising • Always tired • Can't sleep without talking sleeping medication (never used to need anything to sleep) • Joint stiffness and neck pain • Eat high-sugar foods, don't care about my diet anymore 	<ul style="list-style-type: none"> • Constant worrying about my son • Worrying about everything now • Bad anxiety and sadness • I'm always angry or frustrated or depressed these days • I snap at my other children and then feel guilty • I'm angry with my husband – he gets to leave for work all day and leaves me to deal with all of our problems
Social Life	Spiritual Life
<ul style="list-style-type: none"> • Never go out with husband or close friends anymore • Never have guests over for dinner • Can't concentrate on reading • Spend all of our time in emergency rooms or visiting our son on psychiatric wards 	<ul style="list-style-type: none"> • Don't know what this is anymore! • Don't go to church • No time for my daily meditation readings • Don't feel like doing my yoga sessions anymore • Bitter and resentful about my son's illness – why my family?

PERSONAL IMPACT LOG

Physical Health

Emotional Health

Social Life

Spiritual Life

2. The Preoccupation and Impact Scale

How strongly do you agree or disagree with these statements?	Strongly Agree	Agree	Disagree	Strongly Disagree	Don't Know
I can't stop worrying about my family member's illness.	1	2	3	4	9
I am able to maintain a healthy balance in my life.	1	2	3	4	9
I have trouble thinking about anything other than my family member's mental illness and substance use problems.	1	2	3	4	9
I feel that I'm completely preoccupied with my family member's mental illness and substance use problems.	1	2	3	4	9
My daily routine completely centres on my family member's illness.	1	2	3	4	9
I find myself a lot more anxious these days.	1	2	3	4	9
I make sure I find time to do things for myself and to have fun.	1	2	3	4	9
I never feel that I am doing enough for my ill family member.	1	2	3	4	9
Sometimes I feel that I am drowning in my family member's illness.	1	2	3	4	9
I focus so much on my ill relative's problems that I have difficulty finding time to spend on other members of my family.	1	2	3	4	9
I have very little time and energy to socialise with my friends.	1	2	3	4	9
My physical health (eg. nutrition, sleep and rest) has been negatively affected since I've been dealing with my family member's mental health and substance use problems.	1	2	3	4	9
I have had a hard time gaining a sense of emotional well-being since my family member developed mental illness and substance use problems.	1	2	3	4	9
I am able to cope with my loved one's mental illness and substance use problems.	1	2	3	4	9
I think it is OK for family members to feel angry with, or resentful of, their ill loved one.	1	2	3	4	9

3. The Family Concurrent Disorders Index of Concerns Quiz

For each item, circle the number that best corresponds with *how you are feeling right now*. Once you have completed all of the questions, add them up. The higher your total score, the more uneasy, worried or alarmed you are overall about your situation and the more you need to focus on your own emotional, social and physical health and wellbeing.

How concerned am I about...	Not Very										
	Concerned						Concerned				
The immediate overall health and wellbeing of my ill family member?	0	1	2	3	4	5	6	7	8	9	10
The immediate overall health and wellbeing of the other members of my family?	0	1	2	3	4	5	6	7	8	9	10
My own immediate overall health and wellbeing?	0	1	2	3	4	5	6	7	8	9	10
The long term overall health and wellbeing of my ill family member?	0	1	2	3	4	5	6	7	8	9	10
The long term overall health and wellbeing of other members of my family?	0	1	2	3	4	5	6	7	8	9	10
My own long term overall health and wellbeing?	0	1	2	3	4	5	6	7	8	9	10
How much my ill family member is suffering?	0	1	2	3	4	5	6	7	8	9	10
How much the other members of my family are suffering?	0	1	2	3	4	5	6	7	8	9	10
How much I am suffering?	0	1	2	3	4	5	6	7	8	9	10
My ill family member's ability to get through this?	0	1	2	3	4	5	6	7	8	9	10
The ability of my other family members to get through this?	0	1	2	3	4	5	6	7	8	9	10
My own ability to get through this?	0	1	2	3	4	5	6	7	8	9	10
The emotional health of my ill family member?	0	1	2	3	4	5	6	7	8	9	10
The emotional health of other members of my family?	0	1	2	3	4	5	6	7	8	9	10
My own emotional health?	0	1	2	3	4	5	6	7	8	9	10
Whether my ill family member is getting enough social support?	0	1	2	3	4	5	6	7	8	9	10
Whether the other members of my family are getting enough social support?	0	1	2	3	4	5	6	7	8	9	10
Whether I am getting enough social support?	0	1	2	3	4	5	6	7	8	9	10
My ill family member's physical health?	0	1	2	3	4	5	6	7	8	9	10
The physical health of the other members of my family?	0	1	2	3	4	5	6	7	8	9	10
My own physical health?	0	1	2	3	4	5	6	7	8	9	10
The spiritual health of my ill family member?	0	1	2	3	4	5	6	7	8	9	10
The spiritual health of the other members of my family?	0	1	2	3	4	5	6	7	8	9	10
My own spiritual health?	0	1	2	3	4	5	6	7	8	9	10
My ill family member's financial situation?	0	1	2	3	4	5	6	7	8	9	10
The financial situation of the other members of my family?	0	1	2	3	4	5	6	7	8	9	10
My own financial situation?	0	1	2	3	4	5	6	7	8	9	10
My ill family member's journey of recovery?	0	1	2	3	4	5	6	7	8	9	10
The recovery journey of the other members of my family?	0	1	2	3	4	5	6	7	8	9	10
My own journey of recovery?	0	1	2	3	4	5	6	7	8	9	10



FAMILY VIOLENCE



FAMILY VIOLENCE – PRELIMINARY ASSESSMENT

Victorian Government, (2007), *Family Violence: Risk Assessment and Risk Management*, Melbourne: Department of Victorian Communities. Available at: http://www.cyf.vic.gov.au/data/assets/pdf_file/0018/69102/ifvs_risk_assessment_and_risk_management_framework.pdf

The Preliminary Assessment Tool has been accessed from the *Family Violence, Risk Assessment and Risk Management* Manual as referenced above and is part of a one-day training program.

Family violence is a complex area that is often not properly / adequately addressed in family work in the alcohol and other drug sector by virtue of a lack of understanding or knowledge of how to screen or assess for this issue.

This complexity is also due to the fact that there are several forms of abuse, which can occur in a wide variety of family settings.

Risk assessment for family violence should be holistic and take into account safety of all family members – both ‘perpetrator’ and ‘victim’.

The Preliminary Assessment Tool is a tool for professionals who work with victims of family violence but also for whom it is not their core business.

This tool is a useful guide around areas of concern regarding family violence. The risk or vulnerability factor checklist should be explored through the course of the counselling conversation and not used as data collection. The tool has been developed specifically for women and children affected by violence.

Family Violence – Preliminary Assessment

Memory Aide

Note: these risk and vulnerability factors should be explored through the course of a conversation. Risk indicators are not intended to be asked as part of a data collection process and should not be used as such.

Risk or vulnerability factor	Presence of factor	
	Yes	No
Victim		
Pregnancy/new birth*	<input type="checkbox"/>	<input type="checkbox"/>
Depression/ mental health issue	<input type="checkbox"/>	<input type="checkbox"/>
Drug and/or alcohol misuse/abuse	<input type="checkbox"/>	<input type="checkbox"/>
Has ever verbalised or had suicidal ideas or tried to commit suicide	<input type="checkbox"/>	<input type="checkbox"/>
Isolation	<input type="checkbox"/>	<input type="checkbox"/>
Perpetrator		
Use of weapon in most recent event*	<input type="checkbox"/>	<input type="checkbox"/>
Access to weapons*	<input type="checkbox"/>	<input type="checkbox"/>
Has ever harmed or threatened to harm victim	<input type="checkbox"/>	<input type="checkbox"/>
Has ever tried to choke the victim*	<input type="checkbox"/>	<input type="checkbox"/>
Has ever threatened to kill victim*	<input type="checkbox"/>	<input type="checkbox"/>
Has ever harmed or threatened to harm or kill children*	<input type="checkbox"/>	<input type="checkbox"/>
Has ever harmed or threatened to harm or kill other family members	<input type="checkbox"/>	<input type="checkbox"/>
Has ever harmed or threatened to harm or kill pets or other animals*	<input type="checkbox"/>	<input type="checkbox"/>
Has ever threatened or tried to commit suicide*	<input type="checkbox"/>	<input type="checkbox"/>
Stalking of victim*	<input type="checkbox"/>	<input type="checkbox"/>
Sexual assault of victim*	<input type="checkbox"/>	<input type="checkbox"/>
Previous or current breach of intervention order	<input type="checkbox"/>	<input type="checkbox"/>
Drug and/or alcohol misuse/abuse*	<input type="checkbox"/>	<input type="checkbox"/>
Obsession/jealous behaviour toward victim*	<input type="checkbox"/>	<input type="checkbox"/>
Controlling behaviour*	<input type="checkbox"/>	<input type="checkbox"/>
Unemployed*	<input type="checkbox"/>	<input type="checkbox"/>
Depression/mental health issue#	<input type="checkbox"/>	<input type="checkbox"/>
History of violent behaviour (not family violence)	<input type="checkbox"/>	<input type="checkbox"/>
Relationship		
Recent separation*	<input type="checkbox"/>	<input type="checkbox"/>
Escalation – increase in severity and/or frequency of violence*	<input type="checkbox"/>	<input type="checkbox"/>
Financial difficulties	<input type="checkbox"/>	<input type="checkbox"/>

* May indicate an increased risk of the victim being killed or almost killed.

Mental health issues such as depression and paranoid psychosis, which focuses on the victim as hostile, are high risk factors when they are present in conjunction with other risk factors, particularly a previous history of violence. The presence of a mental health issue must be carefully considered in relation to the co-occurrence of other risk factors.

Preliminary Assessment cont.

Victim's own assessment of safety

Has a crime been committed?

Criminal offences include physical abuse, sexual assault, threats, pet abuse, property damage, stalking and breaching intervention orders. (See Classification Code Table for reference).

No Yes If yes, provide details

CASE CLASSIFICATION CODE TABLE *

Instructions: Describe the most serious feature of the current case, and use this code number in the box above.

ASSAULTS				CRIMINAL ABUSE					
		PROPERTY		STALKING		BREACHING I/O			
1	Serious (Physical)	4	Threats (non-physical)	7	Serious (Damage)	10	Less than 2 weeks	13	Only
2	Minor (Physical)	5	Pet Abuse	8	Minor (Damage)	11	Between 2 & 4 weeks	14	Plus Other Charges
3	Sexual	6	Other types of assault	9	Theft	12	Greater than 4 weeks		
NON-CRIMINAL ABUSE									
15	Emotional	Manipulative or controlling behaviour, humiliating or intimidating behaviour, subjecting victim to reckless driving, continual criticism, threatening to take children away or undermining the relationship between victim and children. Threatening to commit suicide.							
16	Verbal	Swearing or making derogatory insults to the victim.							
17	Social	Keeping victim away from family and friends, not letting victim leave the house, insulting victim in public.							
18	Financial	Keeping victim totally dependent, not giving victim enough money to buy things for the household or for basic needs, threatening that victim will lose all victim's property if the relationship ends.							
19	Spiritual	Ridiculing or insulting victim's most valued beliefs about religion, ethnicity, socio-economic background or sexual preferences.							
NON-ABUSIVE AND NON-CRIMINAL BEHAVIOUR									
20	Conflict	Non-violent, non-abusive, non-criminal dispute between family members characterised by the absence of controlling or coercive behaviour							

* This is consistent with the Classification Table used by the Victoria Police in the Family Violence Risk Assessment and Management Report (the L17).

Preliminary assessment cont.

Protective factors

Risk Level

Is risk present? No Yes

Is action required? No Yes

Agencies already involved

Name of organisation	Contact person and number	Type of involvement

Safety plan

--

Preliminary assessment cont.

Referrals made

Type of organisation	Name of organisation	Name of contact person	Date of referral
Police			
Child protection			
Child FIRST			
24-hour state-wide crisis service			
Regional family violence service			
Counselling service			
Housing service			
Community Legal Centre/Legal Aid			
Centrelink			
Mental Health Service			
Drug and Alcohol Service			
Sexual Assault Service			

Consent

I, _____
consent for this practitioner to share the information I have provided in this assessment
with other agencies to which I am being referred

Signature: _____

Date: _____ / _____ / _____

Verbal consent obtained: Yes No

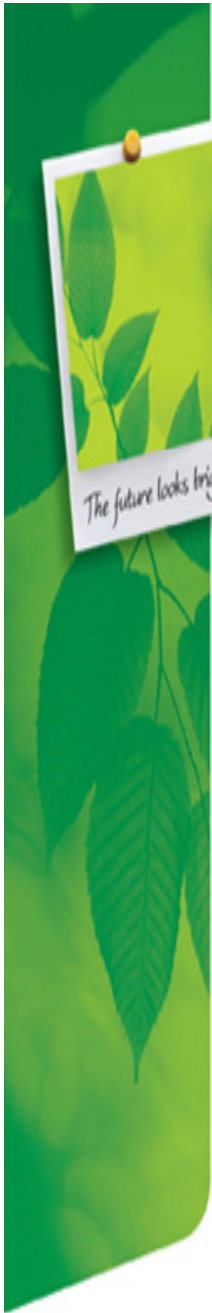

RESOURCES & REFERENCES





RESOURCES

Department of Human Services, (2006), *Parenting Support Toolkit for Alcohol and Other Drug Workers*, Victorian Government Publishing Service
<http://www.health.vic.gov.au/drugservices/pubs/parenting-support.htm>

This resource kit is for all Victorian Alcohol and Other Drug Workers and helps to identify parenting needs by including parenting issues in the assessment process. The Toolkit helps workers respond to the identified parenting needs. It is divided into three books including:

- Exploring Parenting
- Information and Tools
- Services and Resource Guide

Victorian Government, (2007), *Family Violence: Risk Assessment and Risk Management*, Melbourne: Department of Victorian Communities
http://www.cyf.vic.gov.au/_data/assets/pdf_file/0018/69102/ifvs_risk_assessment_and_risk_management_framework.pdf

This resource kit forms part of a one-day training module and offers a framework for working with family violence issues. The framework has seven components including:

- Shared understanding of risk and family violence
- Standardised risk assessment
- Referral pathways and information sharing
- Risk management strategies
- Data collection and analysis
- Quality assurance

Network of Alcohol & other Drugs Agencies, (2009), *Tools for Change: A new way of working with families and carers*, Department of Health, NSW
http://www.nada.org.au/index.php?option=com_content&task=view&id=96&Itemid=25

The toolkit contains a range of interventions, practice tips, service models, resources and training organisations to assist services in working with families. A CD-Rom is also included which contains useful tools such as template policies for working with families, a family inclusive practice workplace audit tool, assessment tools, checklists and a list of family and carer support services.

O'Grady, C.P. & Skinner, W.J., (2007), *A Family Guide to Concurrent Disorders*, Centre for Addiction and Mental Health
http://www.camh.net/publications/resources_for_professionals/partnering_with_families/partnering_families_famguide.pdf

This manual has been developed specifically for families as a self-help resource. It offers an overall understanding of the challenges and opportunities that are present when dealing with a family member who has concurrent disorders. The manual is divided into four parts including:

- What are concurrent disorders?
- The impact on families
- Treatment
- Recovery

The Bouverie Centre Handbook 2010
<http://www.bouverie.org.au/handbook>

This handbook outlines a number of new initiatives as well as academic teaching, training and consultation options and specialist professional development workshops. The handbook is useful for professionals looking for opportunities to further their skills and education in family work. It is divided into five sections including:

- Welcome and general information
- Therapeutic and training resources
- Continuing education
- Academic award courses
- Clinical information



REFERENCES

Department of Human Services, (2006), *Parenting Support Toolkit for Alcohol and Other Drug Workers*, Victorian Government Publishing Service

DrugNet (1997), *Risk Assessment with Parental Drug Use*, DrugNet Professional Drug Management for Clinicians & Educators

Kashner, T.M. et al (1991), *Family Characteristics, Substance Abuse and Hospitalisation*, Hospital and Community, pp195-197

Kina Families and Addictions Trust, (2005), *Family Inclusive Practice in the Addiction Field – A Guide for Practitioners Working with Couples and Families*, Whanau, New Zealand.

McCubbin, H. I., Thompson, A. I., & McCubbin, M. A., (1996), *Family Problem-Solving Communication (FPSC) in Family Assessment: Resiliency, Coping and Adaptation*, Inventories for Research and Practice., 639-684, Edited by McCubbin HI, Thompson AI, McCubbin MA. Madison, University of Wisconsin Press.

Network of Alcohol & other Drugs Agencies, (2009), *Tools for Change, A new way of working with families and carers*, Department of Health, NSW

O'Grady, C.P. & Skinner, W.J. (2007), *A Family Guide to Concurrent Disorders*, Centre for Addiction and Mental Health

Orford, J., Templeton, L., Velleman, R. & Copello, A., (2005), *Family Members of Relatives with Alcohol, Drug and Gambling Problems: A set of standardised questionnaires for assessing stress, coping and strain*, *Addiction*, 100 (11), pp 1611-1624, Society for the Study of Addiction

Price, A.W., & Emshoff, J.G., (1997), *Breaking the Cycle of Addiction: Prevention and intervention with children of alcoholics*, *Alcohol Health & Research World* Vol.21, No.3, pp241-246

Proctor, K., Young, J. & Weir, S., (2006), *Focus on Families: Building confidence to work with families and significant others*, The Bouverie Centre

Victorian Government, (2007), *Family Violence: Risk Assessment and Risk Management*, Melbourne: Department of Victorian Communities.

Young, J., Rycroft, P. & Weir, S., (2006), *Single Session Work*, The Bouverie Centre

